

The Villages®

Architectural Review Manual

VILLAGE COMMUNITY DEVELOPMENT DISTRICT NO. 13, 14 & 15

Version 1.29.25

TABLE OF CONTENTS

Page #

Alternative Energy	1
Arbors	1
Artificial Grass	1
Awnings	2
Bird Feeders	2
Building Additions including Screen Rooms and Screen Cages	2
Building Alterations	3
Carports/Porte Cocheres	3
Driveways, Walkways, Paths, Front Entry Flooring	4
Easements and Property Lines	5
Fences, Railings and Walls	7
Flags	8
Flagpoles	8
Fountains & Waterfalls	8
Front Doors	9
Garage Doors/Screens	9
Gas Tanks, L.P.	9
Gazebos	10
Generators	10
Lamp Posts	10
Landscaping	11
Lawn Ornaments	13
Lightning Rods	13
Lights - Outdoor	14
Painting/Siding of Residence	14
Pergolas	14
Pools	15
Putting Greens	15
Re-Construction Damaged Homes	16
Rentals	16
Roofs	16
Screen Rooms and Screen Cages	16
Setbacks	17
Shade/Privacy Screens	17
Shutters	17
Signs	17
Split A/C Units	18
Stucco/Wood or Stone Veneers	18
Tank-less Water Heaters	18
Tiki Huts	18
Tree Removal	19
Trellises	19
Wall Art	19
Weather Vanes/Stations	19

APPENDICES

I	Courtyard Villa Maintenance and Use Easements
II	Patio Villa Side & Rear Yard Maintenance and Use Easements
III	Veranda Maintenance and Use Easements
IV	Cottage Villa Maintenance and Use Easements
V	Utility Easements
VI	Local Government Road Setbacks
VII	District 13 - VOSO Unit 46 Fences
VIII	Front and Rear Side Yard Easements
IX	Premier, Designer and Cottage Homes Privacy Fence
X	Courtyard Garden Villa Maintenance and Use Easements

These Policies should be used in conjunction with the Declaration of Covenants, Conditions and Restrictions relating to the Unit that contains the homesite that is the subject of the Architectural Review Application.

Some Restrictions contain Declarant imposed building setbacks. Certain vertical structures may be prohibited within these setbacks.

Architectural approval is required for all exterior modifications unless otherwise noted.

Alternative Energy:

Homes (includes Cottage Homes), Verandas, Courtyard Villas, Patio Villas, Cottage Villas

1. Solar panels will be permitted if mounted on the roof (see Ch. 163.04 F.S.). On-ground Solar panels are prohibited.
2. Windmills, wind turbines, and other forms of technology meant to capture wind energy for electricity production are prohibited.
3. Tesla Roofs (See Roofs, pg. 16)

Arbors:

Homes (includes Cottage Homes), Verandas, Courtyard Villas, Patio Villas, Cottage Villas

Arbors may be freestanding, shall be anchored into the ground for safety purposes, shall be located in the rear or side quadrant of the home site, shall not be located in any utility or use easement area and shall have no fences on either side. Only one (1) arbor per lot shall be permitted and shall be consistent with the size of the lot and aesthetics of the neighborhood.

Artificial Grass:

Homes (includes Cottage Homes), Verandas, Courtyard Villas, Patio Villas, Cottage Villas

Artificial grass is not permitted.
(Exception: Artificial grass is permitted to be used in construction of a small putting green. See Putting Greens section.)

Awnings:

Homes (includes Cottage Homes), Verandas, Courtyard Villas, Patio Villas, Cottage Villas

Permanent awnings with vertical structures are prohibited within any utility or use easement area. Architectural approval is not required for retractable awnings. Retractable awnings shall maintain a minimum of two (2) feet from any adjoining building or dividing wall. Color must be aesthetically compatible to the exterior colors of the home.

Bird Feeders:

Homes (includes Cottage Homes), Verandas, Courtyard Villas, Patio Villas, Cottage Villas

Architectural approval is not required for bird feeders. Bird feeders are permitted to be installed on the property as long as the size and height are consistent with the lot size and shall be aesthetically compatible with the style of the neighborhood. Installation of a pole to hang the bird feeder is not permitted in any utility or use easement area. Bird feeders shall not be attached to any courtyard walls or wall fences.

Building Additions:

Including: Screen Rooms/Screen Cages/Screen Front Entry

Notes: 1. All building additions must be attached to the existing dwelling, including being attached by a roof of the same materials, design and roof pitch consistent with the existing home. All building addition materials and design, including roof pitch, shall be consistent with the existing home. No building addition roof shall be higher than the roof of the existing home.

2. Any structure that has a ceiling is considered to be a building addition and shall have a roof that matches the home's roof style, design, materials and color.

3. Any improvements requiring a stem wall or elevated foundation shall be noted, and approximate heights listed on the site plan attached to the Architectural Review Application.

4. When any building addition requires a stem wall or elevated foundation, the applicant is encouraged to install landscaping along that addition for aesthetic purposes.

Homes (includes Cottage Homes), Verandas, Courtyard Villas, Patio Villas, Cottage Villas

1. Screen rooms/Screen cages that were not built during original construction can be added. Screen rooms/screen cages shall have a concrete floor or some type of finished flooring with the exception of

permanently raised landscape planters. Screen rooms/screen cages must have an approved roof style: mansard, dome, etc. Screen rooms/screen cages shall not encroach into any utility or use easements.

2. Canvas roof covers (full and partial) on screen rooms/Screen Cages are allowed. The covers shall be on a metal frame, firmly attached to the existing screen room/birdcage and be in accordance with applicable county, state, and federal regulations. Canvas roof covers shall be a solid color complimenting the color of the home/roof with no stripes or designs allowed. Valances are allowed on full canvas roof covers, may have contrasting piping but cannot exceed 16 inches in length. Valances are not allowed on partial canvas roof covers unless there are different levels in the screen room/birdcage roof. If different levels exist then partial valances are permitted as long as the length is no greater than the difference between levels or 16 inches maximum.
3. Detached, free-standing structures (i.e. a summer kitchen) are permitted as long as they are built under the pool cage, or screen room/birdcage.
4. Screening of the front entryway is allowed. It must be under the existing roof line (not eave line) and on the existing entry way concrete slab. The aluminum frame must match any existing aluminum frame of the home.

Homes (includes Cottage Homes), Verandas, Patio Villas, Cottage Villas

1. Building additions attached to the Home only by a roofed breezeway are not permitted.

Building Alterations:

Verandas, Courtyard Villas, Patio Villas, Cottage Villas

The addition of doors or windows to the side of the home facing an adjacent home's dominant use easement/courtyard is not permitted.

Carports/Porte Cocheres:

All modifications to Carports/Porte Cocheres must be approved by the Developer or its designee. The materials, screen and color of the framing must be compatible with the aesthetics and colors of the neighborhood. Carports/Porte Cocheres may only be used for parking automobiles and golf carts capable of operation, and sitting areas. Carports may not be used for storage, or automobile

or golf cart repair. Carports must be kept neat and clean at all times. Only furniture intended for outdoor use may be placed within carports.

Driveways, Walkways, Paths, Patios, Front Entry Flooring:

Homes (includes Cottage Homes), Verandas, Cottage Villas

1. Painting/Coating: Driveways and walkways may be painted or use pavers. The ARC does not review applications for driveway painting/coating/pavers. Designs are permitted and may include a non-verbiage design. Only colors that are similar with the surrounding neighborhood and will benefit and enhance the entire subdivision in a manner generally consistent with the plan of development are allowed. Non-geometric designs, hot, electric, neon or bright colors are not permitted
2. Walkway and Driveway extensions may be granted only if the extension is affixed to the existing walkway/driveway originally constructed/designed by the Developer and accommodates an existing garage, a garage expansion or addition of a golf cart garage or expansion thereof. No additional access points or curb cuts are permitted except to accommodate the walkway/driveway extension. Walkway extensions are limited to a maximum of 6' wide.
3. Front walkways may be expanded to the width of the front home entryway. Front walkways shall not be expanded towards the street beyond the existing walkway.

Courtyard Villas

1. Painting/Coating: Driveways and walkways may be painted or covered with pavers. Only colors that are similar with the surrounding neighborhood and will benefit and enhance the entire subdivision in a manner generally consistent with the plan of development are allowed. Non-geometric designs, hot, electric, neon or bright colors are not permitted.
2. Driveway extensions/widening are not permitted. Exception: end villas may add extra concrete for parking space provided the existing wall hides concrete
3. Driveways to golf cart garage additions are allowed if: location same as originally constructed sidewalk, it meets intersection or curve safety distances, and it matches existing driveway color/coating. Maximum width is 6'. No encroachment on adjacent properties or adjacent properties' rights.

4. The front entryway is allowed to be widened by pavers/concrete up to the driveway provided that the color and/or blend is harmonious to the existing home.

Patio Villas

1. Painting: Driveways and walkways may be painted or use pavers. Only colors that are similar with the surrounding neighborhood and will benefit and enhance the entire subdivision in a manner generally consistent with the plan of development are allowed. Non-geometric designs, hot, electric, neon or bright colors are not permitted.
2. Driveway, Walkway and Path extensions: Patio Villas may widen their driveway no more than two (2) feet on each side of the driveway. If an adjacent owner has improvements in their side/use easement area (the area of the proposed extensions) the applicant must receive approval from that adjacent owner. The applicant is responsible for any reconstruction, relocation, or demolition of improvements or irrigation in the adjacent owner's side/use easement area.

Easements and Property Lines:

Site plans shall include all utility and use easement areas including but not limited to platted easements, special easements, and easements described in the recorded declaration of deed restrictions.

Owners are responsible and liable for any and all easement encroachments regardless of Developer approval. Owners receiving Developer approval remain liable for any water/drainage flow blockage, interruption of water/drainage flow, redirection of existing drainage flow and any additional water/drainage flow caused by any improvements made to the property including the installation of landscaping. In addition, said Owner is responsible for any damage that may be caused to any said improvements, including landscaping, should access to the easement area be necessary by any party having rights to the easement areas.

Homes (includes Cottage Homes)

No vertical construction of any kind shall be permitted in the utility or use easement areas.

Courtyard Villas, Verandas, Cottage Villas

1. Rear Easements: No vertical construction of any kind shall be permitted in rear easement areas. Patios and walks shall be kept a minimum of two (2) feet from the rear wall.

2. Side/Use Easements: Dominant Use Easement (Owner's side yard enjoyment area)/Servient Use Easements (Owner's side yard burden): No vertical structure of any kind shall be permitted in the servient or dominant easement areas. All vertical structures shall be kept a minimum of five (5) feet from the side property line on the dominant easement side. Patio and walkways shall be a minimum of two (2) feet from the exterior of the side dwelling wall of the servient tenement. Additionally, rear room additions may extend to the servient easement side wall/fence; however, all other modifications (i.e. screen cages, pergolas, concrete slabs, walks and the like) to the rear of the home must remain two (2) feet from the servient easement side wall/fence for maintenance purposes. If the Rule does not address side easements, all structures of any kind shall be kept a minimum of five (5) feet from property line for aesthetic, uniformity and drainage purposes.
3. Front Yard/Driveway Area/Use Easements: Due to the courtyard villa's unique design, easement rights, limited pervious surface and aesthetic uniformity, no modifications shall be allowed in the front yard or driveway easement area with the exception of landscaping.

Patio Villas

1. Rear Easements: No vertical construction of any kind shall be permitted in rear easement areas.
2. Side/Use Easements: Dominant Use Easement (Owner's side yard enjoyment area)/Servient Use Easements (Owner's side yard burden): No vertical structure of any kind shall be permitted in the servient easement. No vertical structure of any kind shall be permitted within the dominant use easement area. In said dominant use easement area, patios and walkways shall be kept a minimum of two (2) feet from the exterior of the side dwelling wall of the servient tenement. If the Rule does not address side easements, all structures, except for patio and walkways, shall be kept a minimum of five (5) feet from the side property line. Patio and walkways shall be a minimum of two (2) feet from the side property line for aesthetic, uniformity and drainage purposes.
3. Front Yard/Driveway/Use Easements: Due to the patio villa's unique design, easement rights, limited pervious surface and aesthetic uniformity, no structural modifications, other than permitted driveway extensions, shall be allowed in the front yard or driveway easement area.

Fences, Railings and Walls:

This section does not prevent statutorily required fencing such as pool fencing.

Some Units may allow fences or walls – Location and Specification requirements will either be found in the Appendices or the individual unit Restrictions.

In non-walled units where the Developer has originally constructed walls along the rear homesite lines, no other walls are permitted.

Homes (includes Cottage Homes), Verandas, Courtyard Villas, Patio Villas, Cottage Villas

1. There are no prohibitions on invisible electronic fences for pets.

Homes (includes Cottage Homes)

1. Fences may be used to screen condenser/compressor units, pool pumps and related equipment and shall be no higher than 48” and shall be consistent with the aesthetics of the neighborhood.
2. Railings or fences are permitted around patio slabs so long as they are wrought iron, aluminum, brick, stone, or plastic, no higher than 48”, the appearance of being attached to the home, and shall be consistent with the aesthetics of the neighborhood.
3. Railings or fences are permitted across the front entry of the home so long as they are wrought iron, aluminum, brick, stone or plastic, no higher than 48”, have the appearance of being attached to the home, remain under the existing roof line, and shall be consistent with the aesthetics of the neighborhood.
4. No other fences or railings are permitted.

Courtyard Villas, Verandas, Cottage Villas

1. No fences are permitted on the front of the Courtyard Villa.
2. A white vinyl, wrought iron, aluminum, or plastic railing may enclose a front porch as long as it is under the existing porch roof.
 - a. A knee wall may enclose a front porch as long as it is under the existing porch roof. Knee walls may also be extended outside of the roof line, as long there is a minimum of a one

(1) foot strip of landscaping between the outside of the knee wall and the driveway.

3. Should the construction of an addition require the removal of any section of a neighboring common wall or fence the Applicant must return the removed section of a wall or fence wall to its original design form, materials, and aesthetics as either a portion of the new construction, where permitted, and/or as a “stand alone” section as it originally existed.

Patio Villas

1. Other than originally constructed, fences and railings are prohibited.
2. Removal of the originally constructed fences and railings is not permitted.

Flags:

The design, material, and subject of the flag is not regulated by the Developer. All flags must be consistent with the size of the lot and flag pole. All flags must be hung from a flagpole that is either free-standing or attached to the dwelling.

Flagpoles:

Homes (includes Cottage Homes), Verandas, Courtyard Villas, Patio Villas, Cottage Villas

1. One (1) free-standing flagpole is allowed, but shall not exceed a maximum height of twenty two (22) feet or encroach any easements.
2. One (1) flagpole attached to the dwelling is allowed, but the size must be consistent with the dwelling size and style compatible with the aesthetics of the neighborhood.

Fountains & Waterfalls:

Homes (includes Cottage Homes), Verandas, Courtyard Villas, Patio Villas, Cottage Villas

Fountains and waterfalls shall be consistent with the lot size. Fountains and waterfalls are not permitted in utility or use easement areas.

Front Doors:

Homes (includes Cottage Homes), Verandas, Courtyard Villas, Patio Villas, Cottage Villas

No specifications required for front doors as to type or color. Glass/screen doors are permitted.

Architectural approval is not required for front door modifications, including, but not limited to, glass inserts, glass side panels, screen doors, storm doors or door color. An architectural application form is required if said modification is to increase the height or width of the door.

Garage Doors/Screens:

Homes (includes Cottage Homes), Verandas, Courtyard Villas, Patio Villas, Cottage Villas

Architectural approval is not required for garage door or screen modifications to install or remove glass, decorative panels, garage door screen or garage door painting if the chosen color is compatible with the aesthetics and colors of the neighborhood. Any modifications to the height or width of the garage door requires review approval.

Gas Tanks, L.P.:

Courtyard Villas, Verandas, Cottage Villas

Underground or above ground L.P. tanks are permitted. Above ground L.P. tanks are restricted to a maximum size of tank 120 gallons and must not be visible from the road or the adjacent neighbors' property. All L.P. tanks must meet local, state, and federal policies and regulations including any easement and setback regulations.

Homes (includes Cottage Homes) and Patio Villas

L.P. tanks must be underground and must meet Developer, local, state, and federal policies and regulations including any easement or setback regulations. No underground gas tanks in utility or use easements.

Gazebos:

Homes (includes Cottage Homes), Verandas, Courtyard Villas, Patio Villas, Cottage Villas

A gazebo is a freestanding, roofed, open-sided structure providing a shady resting place and is permitted. Only one (1) gazebo per lot is permitted, shall not be in any utility or use easement area, shall be located in the rear quadrant of the home site, the gazebo shall be consistent with the size of the lot, and the roof material shall be the same as the existing dwelling.

Generators:

Owners seeking to provide a back-up energy source to their dwelling are only required to fill out an Architectural Review application for generators that will be permanently affixed to the property and dwelling.

Homes (includes Cottage Homes), Verandas, Courtyard Villas, Patio Villas, Cottage Villas

Permanently fixed generators shall be placed in the rear or the side of the home site and must not be visible from the street. Fences may be used to screen generators and shall be no higher than the generator. The exhaust of the generator must be directed away from the adjacent neighboring properties. The generator's size must be consistent with the size of the lot. Generators may not be placed in any set back or use easement area.

Lamp Posts:

Homes (includes Cottage Homes), Verandas, Courtyard Villas, Patio Villas, Cottage Villas

In neighborhoods where lamp posts are optional, all aftermarket lamp posts and lamp post signs must have an approved Architectural Review Application. Only one lamp post on each homesite. The lamp post shall be in the front yard near the driveway and front entry of the home. The location, size, style and color of the lamp post and lamp post sign shall be compatible with the surrounding neighborhood. The lamp post sign may contain the customary name and address of the home owners and may be lighted.

For homesites that do not have a lamp post, a lighted name and address sign may be attached to the front of the home near the front entry. The location, size, style, color and brightness of the lighted name and address sign shall be compatible with the home and surrounding neighborhood.

Landscaping:

Once landscaping is planted, it must be kept trimmed two (2) feet from house/wall.

1. A deed restriction or covenant may not prohibit or be enforced to prohibit any property owner from implementing Florida-friendly landscaping on his or her land.
 - a. Florida-friendly landscaping refers to the utilization of drought tolerant “plants”. It does not mean that sod may be replaced with rocks, decorative stone, pine straw, mulch, pine bark or similar non-plant material; however, those non-plant materials may be used as an accent around plantings in designated approved landscaping beds.
2. Courtyard and Courtyard Garden Villas’ sod, landscaping beds, and plantings may be replaced with rock, mulch, or mulch products provided that there is an aesthetically acceptable amount of Florida-friendly plantings within those areas.
3. Owners shall comply with, and be liable for any non-compliance with, the applicable construction plan for the surface water management system pursuant to the approved plan on file with the applicable state water management district.
4. Property owner is liable for any resulting blockage, interruption, or redirection of existing drainage flow, any additional drainage flow or any type of easement encroachment(s).
5. Landscaping walls shall be no higher than eighteen (18) inches. However, landscaping walls may exceed eighteen (18) inches in height, if necessary, due to existing lot elevations.

Landscaping (including, but not limited to, curbing, hedging and landscaping walls)

Note: This section refers to new/additional landscaping, including the landscaping beds and not landscaping or landscape beds originally installed at time of construction.

Homes (includes Cottage Homes)

1. Landscaping, including the landscaping beds, shall be kept a minimum of three (3) feet from the side and rear property lines for storm water maintenance/drainage purposes.

2. Existing sod or other plant material shall only be replaced with sod or other plant material. Rock is not an acceptable replacement for sod or other plant material(s) except as an accent material in approved landscaping beds.

Verandas

1. Side Yard: Landscaping, including the landscaping beds, shall not disturb the grading of the dominant easement area, shall be kept a minimum of three (3) feet off the dominant tenement side yard wall/fence. Landscaping shall also be kept a minimum of three (3) feet off the side yard wall for storm water maintenance/drainage.
2. Front Yard: Landscaping, including the landscaping beds, in the front yard area is permitted, but must comply with use easements.
3. Rear Yard: Landscaping, including the landscaping beds, shall be kept a minimum of three (3) feet from the rear lot line for maintenance and drainage purposes.

Courtyard Villas, Courtyard Garden Villas, Cottage Villas

1. Side Yard: Landscaping shall be kept a minimum of two (2) feet off the dominant tenement side yard wall/fence, servient tenement wall and servient tenement driveway. Once landscaping is planted, it must be kept trimmed two (2) feet from house/wall.
2. Front Yard: Landscaping, including the landscaping beds, in the front yard area is permitted, but must comply with use easements.
3. Rear Yard: Landscaping shall be kept a minimum of two (2) feet from the rear lot line for maintenance and drainage purposes.

Patio Villas (Side Yard Living)

1. Side Yard: Landscaping shall not disturb the grading of the dominant easement area, shall be kept a minimum of two (2) feet off the dominant tenement side yard wall/fence, a minimum of two (2) feet off the servient tenement wall and driveway for storm water maintenance/drainage. Once landscaping is planted, it must be kept trimmed two (2) from house/wall.
2. Front Yard: Landscaping, including the landscaping beds, in the front yard area is permitted including the dominant easement area; however, it is not permitted in the front or servient easement areas. Hedges are only permitted in front of the fence as originally constructed, repaired or replaced.

3. Rear Yard: Landscaping, including the landscaping beds, shall be kept a minimum of two (2) feet from the rear lot line for maintenance and drainage purposes.
4. Existing sod shall only be replaced with sod or other plant material except as an accent material in approved landscaping beds.

Patio Villas (Rear Yard Living)

1. Landscaping, including the landscaping beds, shall be kept a minimum of three (3) feet from the side and rear property lines for storm water maintenance/drainage purposes.
2. Existing sod or other plant material shall only be replaced with sod or other plant material. Rock is not an acceptable replacement for sod or other plant material(s) except as an accent material in approved landscaping beds.

Lawn Ornaments:

Homes (includes Cottage Homes), Verandas, Courtyard Villas, Patio Villas, Cottage Villas

Lawn Ornaments are prohibited. Lawn Ornaments, or yard art, generally refers to manmade items located anywhere outside the structure or footprint of the home. However, pots and planters designed and constructed for plant use are permitted so long as they are used for their intended purpose. The inclusion or attachment of flowers or plants to a manmade ornament, not originally constructed for plant use, does not change the item from a lawn ornament to landscaping. The word "lawn" includes areas that are mulched, concreted, sodded, rocked, landscaped, bare earth or any other material outside the structure (footprint) of the home. The following is intended as a partial list of lawn ornaments: any man made statute or figure, wind chimes, plastic or silk flowers, windmill, pinwheels, train sets, deer, geese, flamingos or any other animal or human figures.

Lightning Rods:

Homes (includes Cottage Homes), Verandas, Courtyard Villas, Patio Villas, Cottage Villas

Lightning rods may be installed on a dwelling without an ARC approval. The number of lightning rods and size must be compatible and consistent with the size and style of the dwelling and aesthetics of the neighborhood.

Lights – Outdoor:

Homes (includes Cottage Homes), Verandas, Courtyard Villas, Patio Villas, Cottage Villas

Low voltage landscape lighting is permitted but their positioning may not result in light shining or glaring into an adjacent residence. Exterior lighting must be attached to the home or screen cage and shaded so as not to create a nuisance to others. No other light poles may be erected. Exterior strip lighting, liquid lights and similar light sources are prohibited.

Painting/Siding of Residence (Base or Trim):

Note: Hot, electric, neon or bright colors are not permitted

Homes (includes Cottage Homes), Verandas, Cottage Villas

Only solid colors that are similar to the surrounding neighborhood and will benefit and enhance the entire neighborhood in a manner generally consistent with the plan of development are permitted.

Courtyard Villas and Patio Villas

When repainting the residence the color shall be the same as original, a color already existing in the villa unit, or another color approved by the Developer, as long as villas on either side are not of same color. Trim, shutters, and front doors must be a color that is aesthetically compatible with the base color of the home.

Courtyard Villas

If Villa Subdivisions have some villas with decorative stone veneer, villas that do not have stone veneer can add it.

Patio Villas

Siding may be replaced as long as approved siding colors are used and as long as homes on either side are not of same color.

Pergolas:

Homes (includes Cottage Homes), Verandas, Courtyard Villas, Patio Villas, Cottage Villas

Only one (1) pergola per lot is permitted. Pergolas shall not be located in any easement or setback area, shall be anchored into the ground for safety purposes and shall be located in the rear or side quadrant of the lot except

on those models such as the Indigo, where the Developer originally installs a pergola over the front entry of the home. Pergolas shall be consistent with lot size. Pergolas constructed with a concrete pad may be screened on the sides and roof. Pergolas may have a sunshade canopy. The canopy may be stationary, retractable, louvered, or shade sail. All canopy products shall be a solid color similar to the color of the dwelling. "Elite" roof systems or "Santa Fe" style pergolas are not permitted. Any structure that has a ceiling is considered to be a building addition and shall have a roof that matches the home's roof style, design, materials, color and roof pitch.

Pools:

Free standing outdoor bathrooms, showers and changing areas are not permitted. They must be compliant with the requirements under Building Additions.

Privacy walls are permitted on pool decks, patios or lanais. The privacy walls may not be higher than the eaves of the existing home.

Any improvements requiring a stem wall or elevated foundation shall be noted, and approximate heights listed on the site plan attached to the Architectural Review Application.

When any pool deck requires a stem wall or elevated foundation, the applicant is encouraged to install landscaping along the pool deck for aesthetic purposes.

Putting Greens:

Homes (includes Cottage Homes), Verandas, Courtyard Villas, Patio Villas, Cottage Villas

Putting greens are permitted as long as:

1. They are built on the rear of the property.
2. Not visible to the road in front of the house.
3. They are consistent with the size of the lot and are aesthetically compatible with the neighborhood.
4. Not located in any easement area.

Note: Artificial grass may be used in the construction of a putting green.

Re-Construction Damaged Homes:

Homes (includes Cottage Homes), Verandas, Courtyard Villas, Patio Villas, Cottage Villas

The general rule of thumb is to follow the time limits in the Restrictions and ARC Application, however, there may sometimes be unusual circumstances that make it impossible to follow these limits. In those instance the Developer could choose to not enforce the time limits in both of these issues by granting extensions if the home owner could produce sufficient evidence that any delays were beyond their control. Some examples would be waiting on fire investigation, insurance approval, permitting, financing, existing lender approvals, materials or availability of contractors. Obviously, any threats to public health, safety and aesthetics should be considered when granting any extensions

Rentals:

In some neighborhoods, rentals may be restricted or may have minimum lengths of rental.

Roofs:

Homes (includes Cottage Homes), Verandas, Courtyard Villas, Patio Villas, Cottage Villas

All roofs, including Tesla, metal shingle roofs and metal roofs, shall be consistent in color and style of the home and within the neighborhood, and all roofing shall require architectural approval. Metal roofs shall be standing seam style.

Screen Rooms and Screen Cages:

Homes, Verandas, Courtyard Villas, Patio Villas, Cottage Villas

2. Pre-printed or painted screens on screen rooms and screen cages are prohibited.
3. Screen cages must have approved roof styles; mansard, half mansard, dome, hip or gable style.
4. Free standing structures such as outdoor bathrooms, shower rooms or changing rooms are not permitted.

Setbacks:

Homes, Verandas, Courtyard Villas, Patio Villas, Cottage Villas

Vertical Construction is not permitted within any Developer, City, or County imposed setback. Applicants are responsible for compliance with setbacks.

Shade/Privacy Screens:

Homes (includes Cottage Homes), Verandas, Courtyard Villas, Patio Villas, Cottage Villas

Retractable shade/privacy screens are permitted on screen cages or lanais and do not need AR approval. The shade/privacy screens must match the aesthetics of the home and surrounding neighborhood. Pre-printed or painted shade/privacy screens are not permitted.

Shutters:

Homes (includes Cottage Homes), Verandas, Cottage Villas

Shutters are permitted. Color of shutters can be changed as long as color is aesthetically compatible with the base color and consistent with the aesthetics of the neighborhood.

Courtyard Villas and Patio Villas

Shutters shall be mounted in an unhinged fixed position. Color of shutters can be changed as long as color is consistent with neighborhood, but the color cannot match the color on adjacent villas.

Note: Storm shutters are permitted as long as they are professionally manufactured and are aesthetically compatible with the home. Temporary hurricane protections are not subject to Architectural Review, but must be removed within seven (7) days of the storm passing.

Signs

Homes (includes Cottage Homes), Verandas, Courtyard Villas, Patio Villas, Cottage Villas

Customary name and address signs on the outside of the home are permitted. Signs that are for the safety of the public or are specifically required through local, state, or federal statutes are permitted.

Note: Restrictions on signage may be different in some of the Districts in this Manual. Please consult the individual Restrictions on the subdivision you are working on. Some Restrictions may prohibit signs.

Split A/C Units:

Homes (includes Cottage Homes), Verandas, Courtyard Villas, Patio Villas, Cottage Villas

Split A/C units are permitted. The outside portion of the split unit must be placed along the side or rear of the home. The outside portion of the split unit shall not be placed in any adjacent homesites dominant use easement.

Stucco/Wood, or Stone Veneers:

Homes (includes Cottage Homes), Verandas

Stucco on a portion or all of a home is permitted. Wood or stone veneer is only permitted on a portion of the home as accent. The color and style of stucco/wood or stone veneers must be compatible with the aesthetics of the neighborhood.

Stucco/Wood or Stone veneers are not permitted on the gables.

Note: Adding stucco/wood, or stone veneers to a home not originally stucco/wood, or stones veneer may void structural warranties.

Tank-less Water Heaters:

Homes (includes Cottage Homes), Verandas, Courtyard Villas, Patio Villas, Cottage Villas

Tank-less water heaters are permitted to be installed on the outside of the home or villa. They may not be placed on the front of the dwelling facing the road.

Tiki Huts

Homes (includes Cottage Homes), Verandas, Courtyard Villas, Patio Villas, Cottage Villas

A Tiki Hut is a freestanding, thatched roofed (natural or synthetic, open-sided structure providing a shady resting or dining place, outdoor kitchen and/or bar and is only permitted within an approved screen cage, pool cage or lanai. Tiki Huts shall be consistent with the size of the screen

cage, pool cage or lanai and shall be compatible with the aesthetics of the dwelling unit and neighborhood.

Tree Removal

Homes (includes Cottage Homes), Verandas, Courtyard Villas, Patio Villas, Cottage Villas

Tree removal does not require Declarant approval. It is the homeowners' responsibility to make sure any tree removal on their homesite is in compliance with all applicable City of Wildwood tree ordinances.

Trellises:

Homes (includes Cottage Homes), Verandas, Courtyard Villas, Patio Villas, Cottage Villas

A trellis is a two dimensional structure of open lattice work which may be freestanding and is permitted but shall not be permitted in any utility or use easement area. The trellis shall be consistent with the size of the lot and compatible with the aesthetics of the neighborhood. Only one trellis structure is permitted per homesite (multiple sections of trellis can be combined to create a single trellis structure).

Wall Art:

Homes (includes Cottage Homes), Verandas, Courtyard Villas, Patio Villas, Cottage Villas

1. Wall art that is painted is not permitted.
2. Outdoor attached decorations, excluding common holiday displays, or any pieces of art that are permanently or temporarily affixed to the outside of the dwelling are permitted. The size and colors must be compatible with the dwelling. The style must be consistent with the aesthetics of the neighborhood.

Weather Vanes/Stations:

Homes (includes Cottage Homes), Verandas, Courtyard Villas, Patio Villas, Cottage Villas

Weather vanes/stations are permitted as long as they are securely attached to the roof of the dwelling. The size and height must be consistent with the lot size and the style must be aesthetically compatible with the neighborhood.

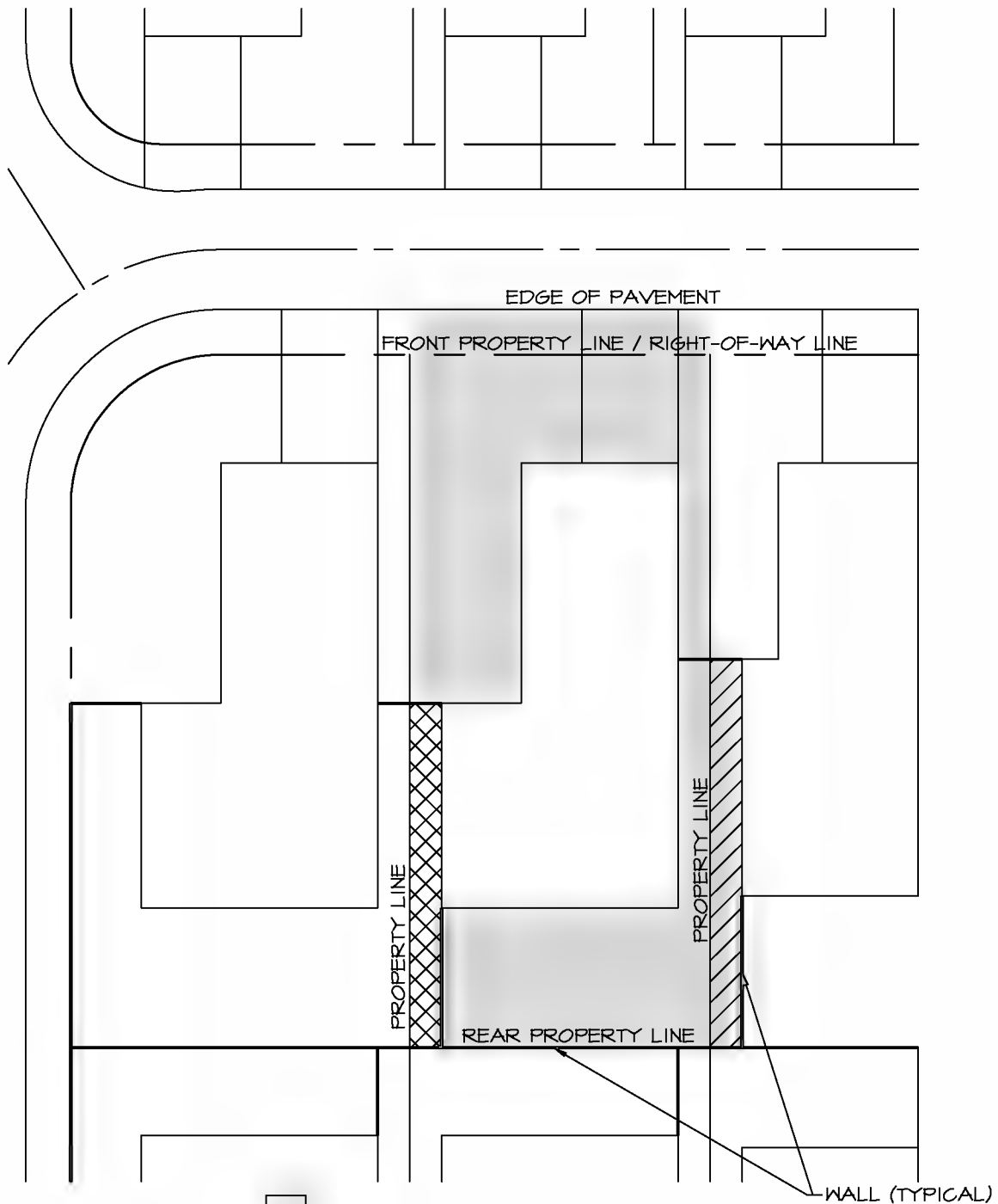

- MAINTENANCE AND USE AREA
- DOMINANT USE EASEMENT AREA
- SERVIENT USE EASEMENT AREA

STANDARD LOT "FRONT LOAD" MAINTENANCE AND USE EASEMENTS

ISSUE DATE 11-1-21

NOT TO SCALE

<p>ARCHITECTURAL REVIEW POLICY & STANDARDS</p>	REVISIONS							
	<p>Courtyard Villa Maintenance and Use Easements</p>							

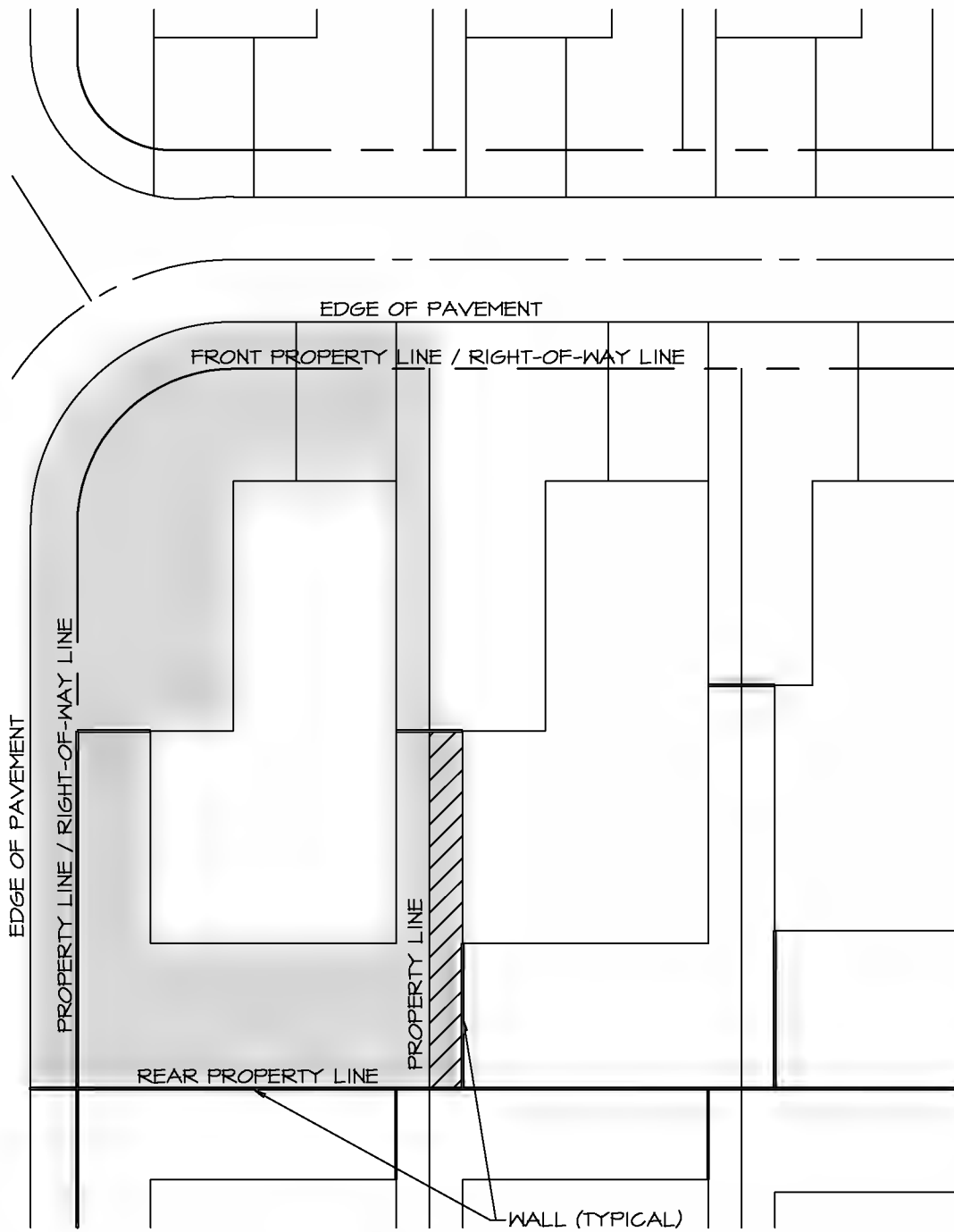

- MAINTENANCE AND USE AREA
- DOMINANT USE EASEMENT AREA

CORNER LOT "FRONT LOAD" MAINTENANCE AND USE EASEMENTS

ISSUE DATE 11-1-21

NOT TO SCALE

 ARCHITECTURAL REVIEW POLICY & STANDARDS	REVISIONS								
	Courtyard Villa Maintenance and Use Easements								PAGE

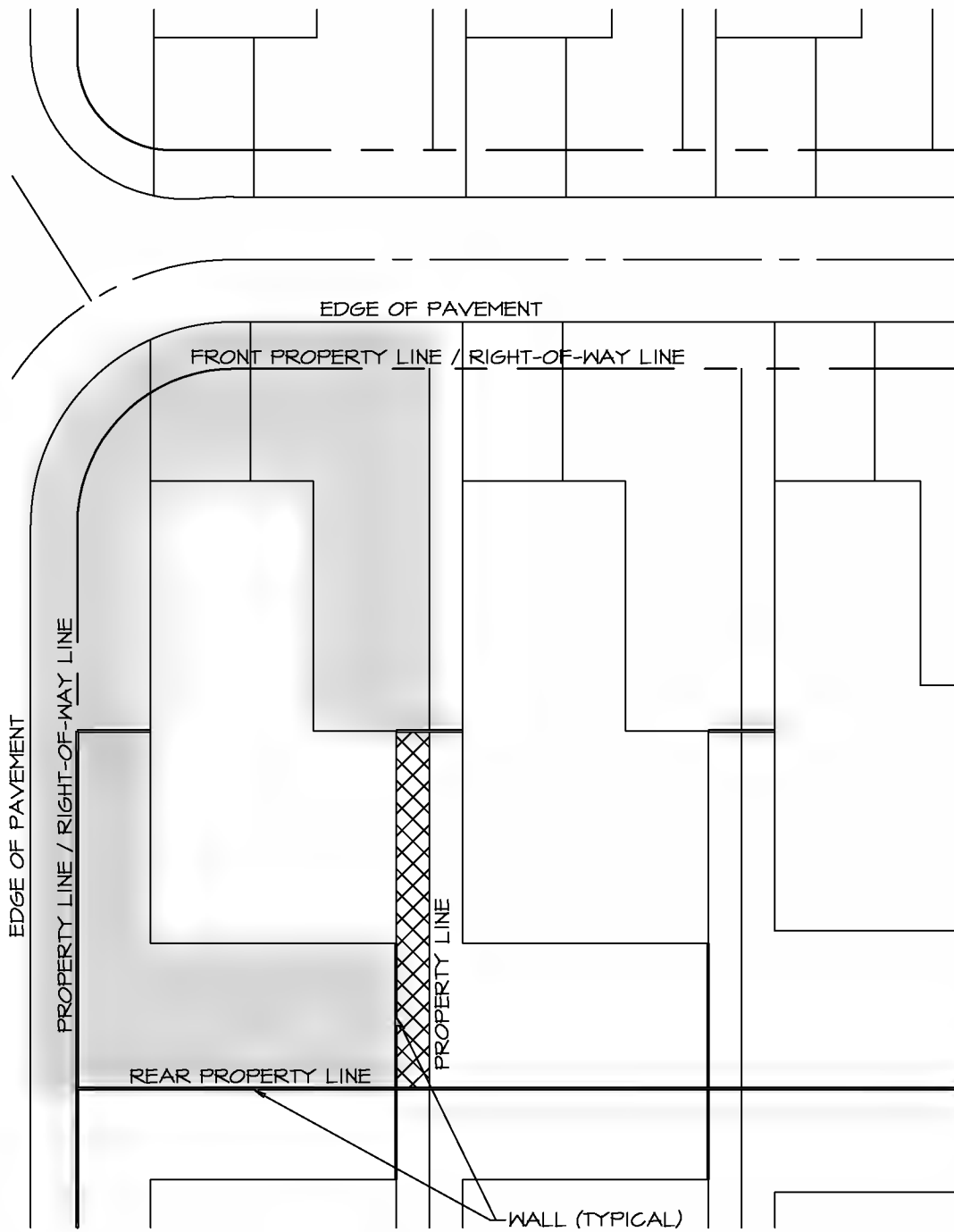

- MAINTENANCE AND USE AREA
- SERVIENT USE EASEMENT AREA



CORNER LOT "FRONT LOAD" MAINTENANCE AND USE EASEMENTS

ISSUE DATE 11-1-21

NOT TO SCALE

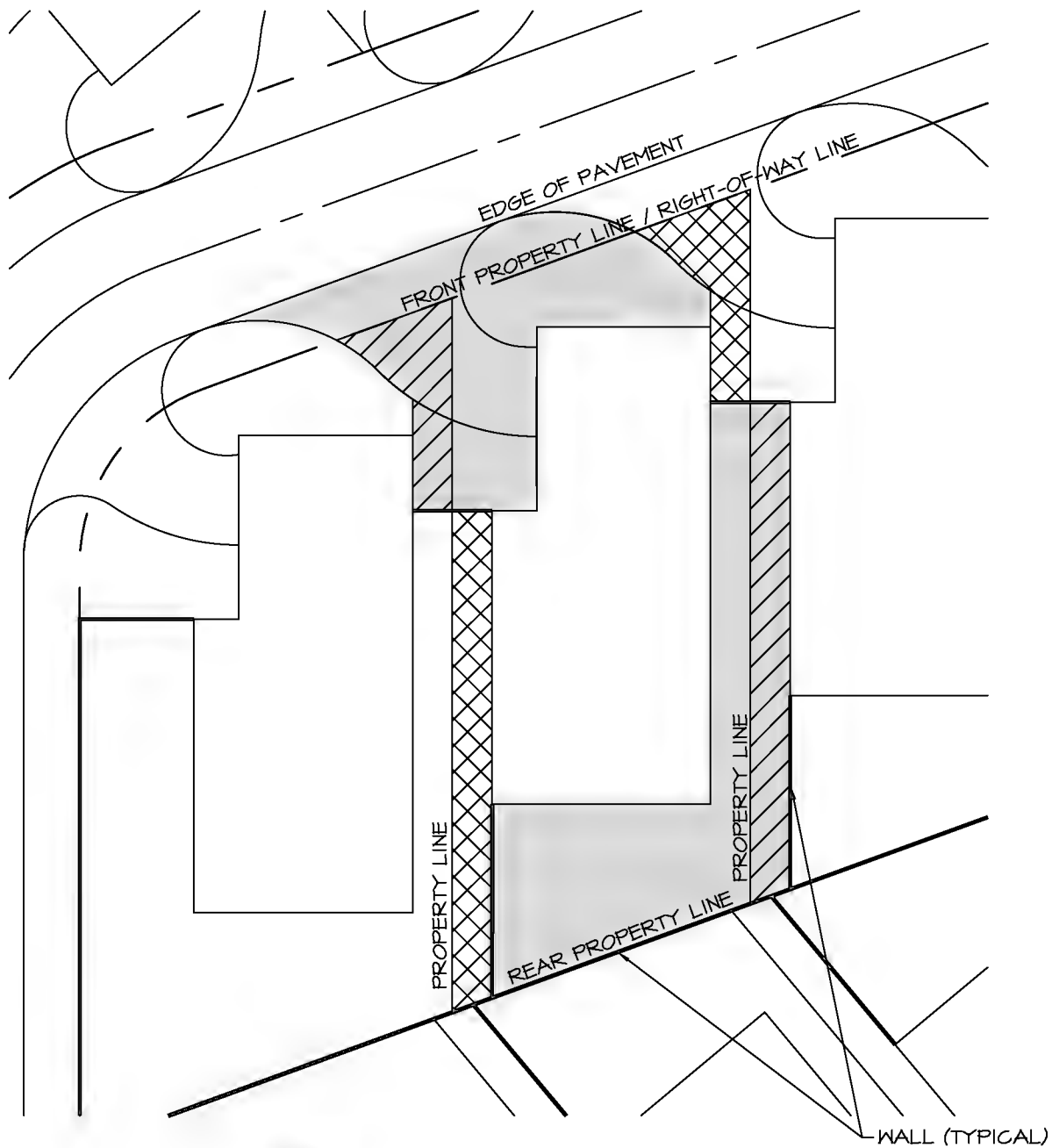
<p>ARCHITECTURAL REVIEW POLICY & STANDARDS</p>	REVISIONS							
	<p>Courtyard Villa Maintenance and Use Easements</p>							PAGE



-  MAINTENANCE AND USE AREA
-  DOMINANT USE EASEMENT AREA
-  SERVICENT USE EASEMENT AREA

STANDARD LOT "SIDE LOAD" MAINTENANCE AND USE EASEMENTS

ISSUE DATE 11-1-21

NOT TO SCALE

 ARCHITECTURAL REVIEW POLICY & STANDARDS	REVISIONS								
	Courtyard Villa Maintenance and Use Easements								PAGE

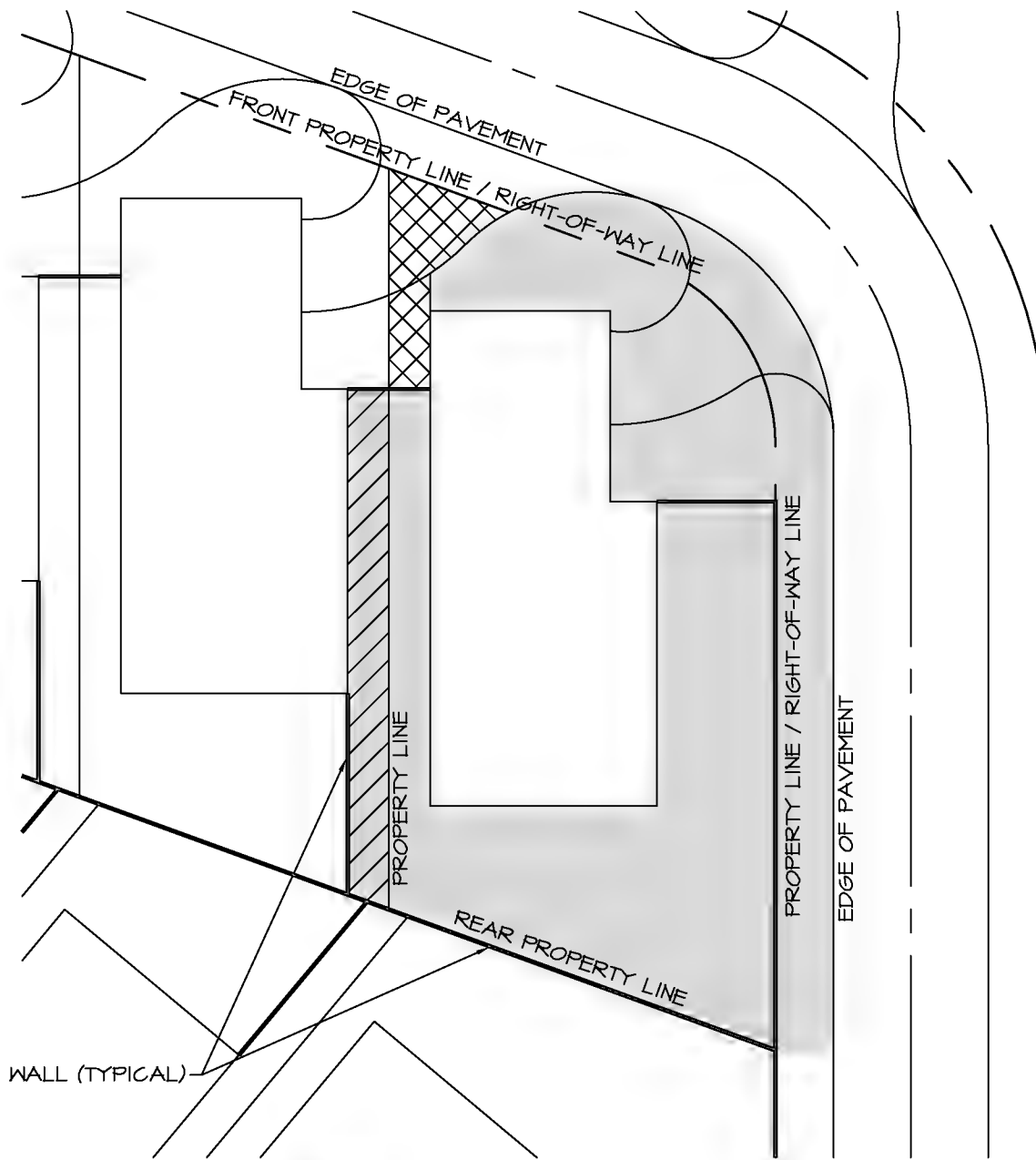

- MAINTENANCE AND USE AREA
- DOMINANT USE EASEMENT AREA
- SERVIENT USE EASEMENT AREA

CORNER LOT "SIDE LOAD" MAINTENANCE AND USE EASEMENTS

ISSUE DATE 11-1-21

NOT TO SCALE

<p>ARCHITECTURAL REVIEW POLICY & STANDARDS</p>	REVISIONS							
	<p>Courtyard Villa Maintenance and Use Easements</p>							

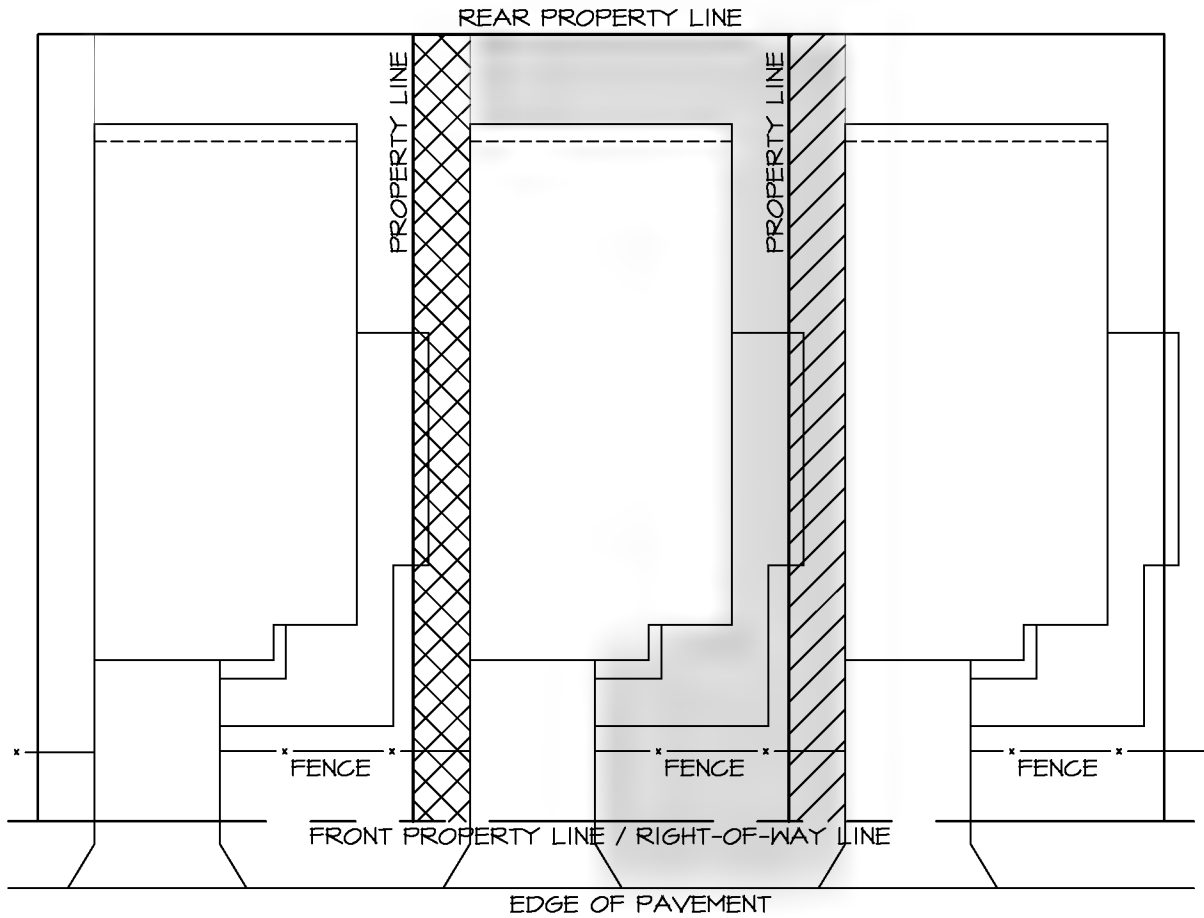

PATIO SIDE LIVING LOT MAINTENANCE AND USE EASEMENTS

ISSUE DATE 11-1-21

NOT TO SCALE

 <p>ARCHITECTURAL REVIEW POLICY & STANDARDS</p>	REVISIONS							
	<p>Patio Villa Maintenance and Use Easements</p>							PAGE

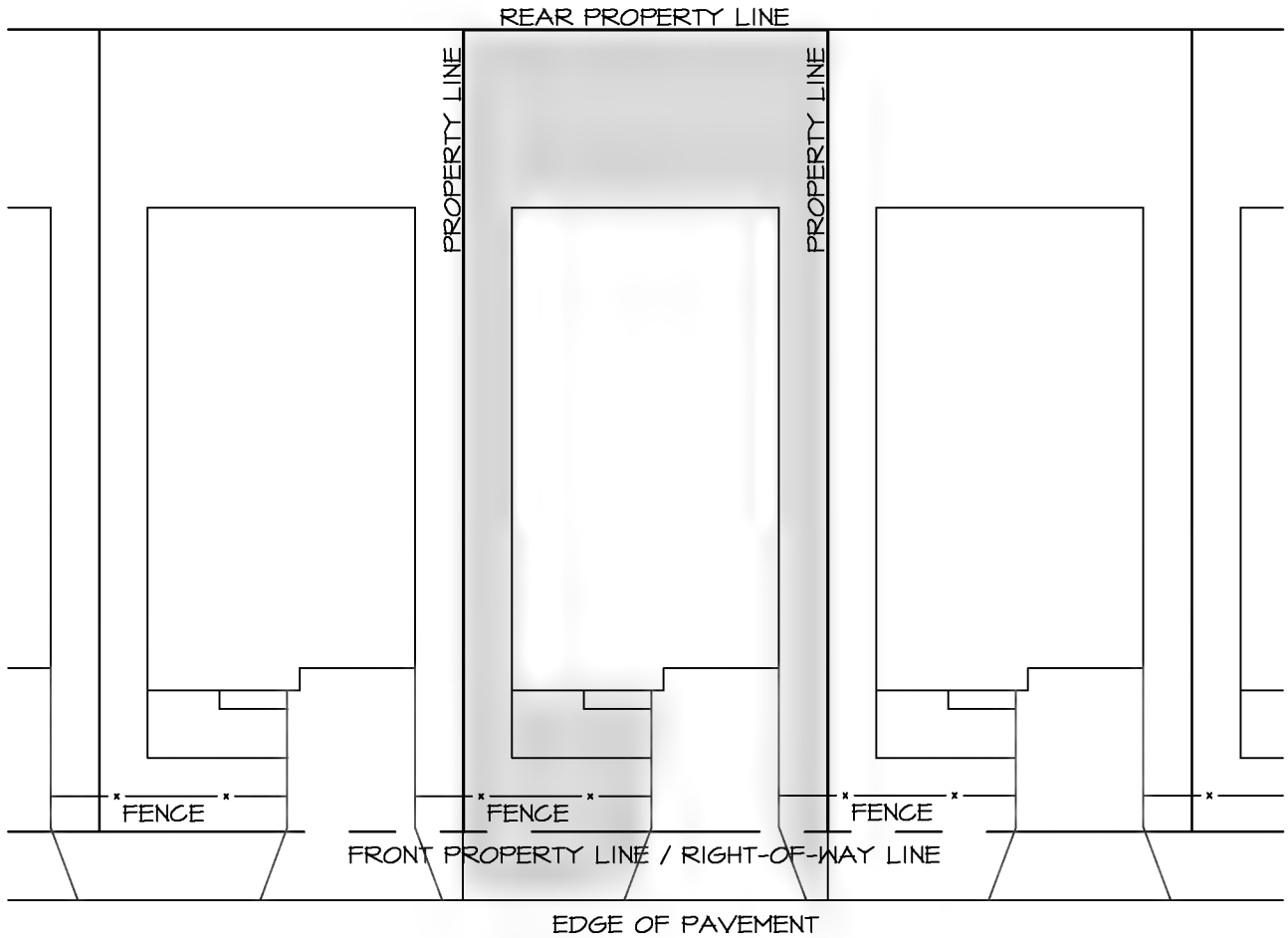



 MAINTENANCE AND USE AREA

PATIO REAR LIVING MAINTENANCE AND USE

ISSUE DATE 11-1-21

NOT TO SCALE

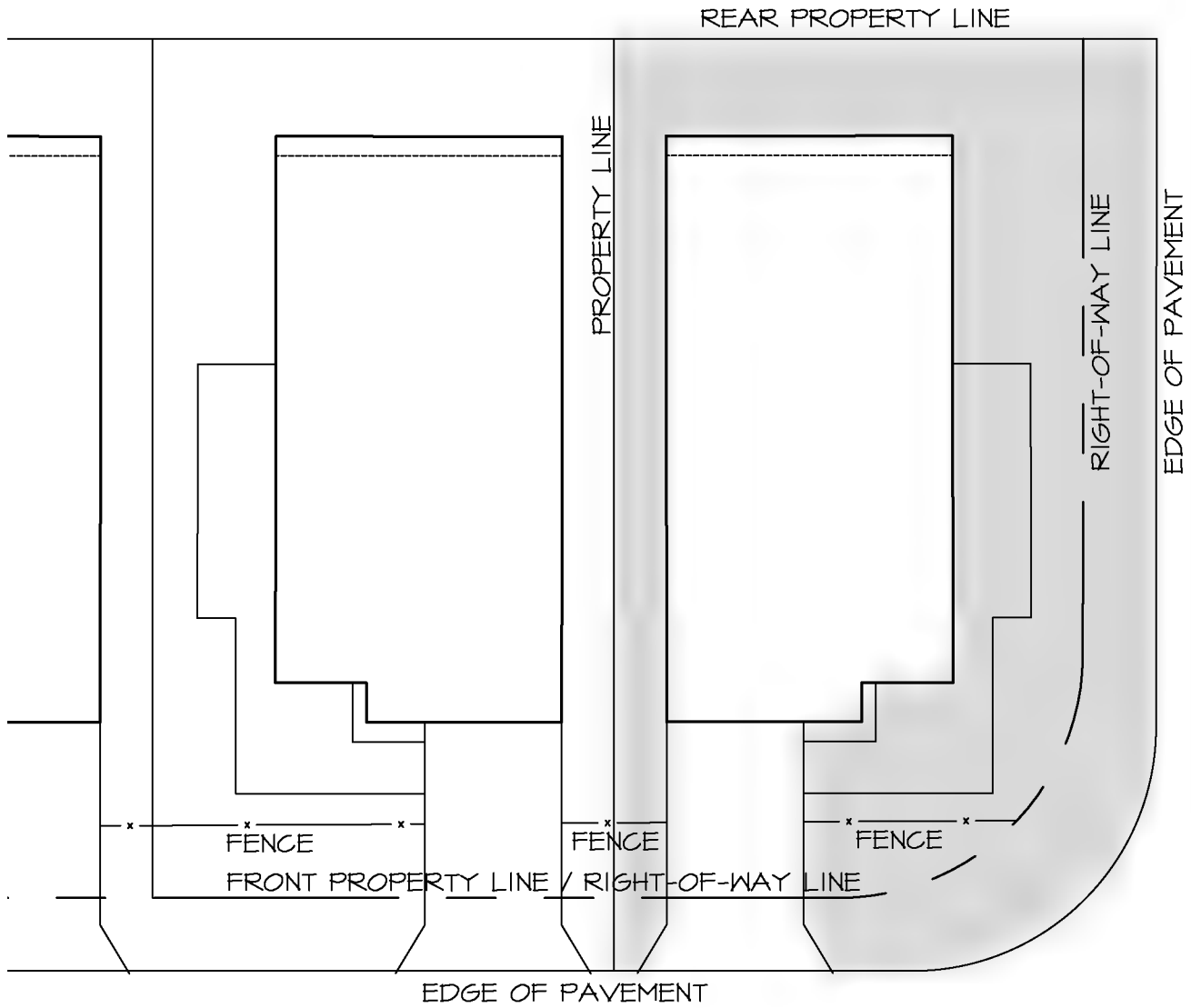
 ARCHITECTURAL REVIEW POLICY & STANDARDS	REVISIONS								
	Patio Villa Maintenance and Use								PAGE APPENDIX II



MAINTENANCE AND USE AREA

CORNER REAR LIVING MAINTENANCE AND USE

ISSUE DATE 11-1-21

NOT TO SCALE

 <p>ARCHITECTURAL REVIEW POLICY & STANDARDS</p>	REVISIONS								
	<p>Patio Villa Maintenance and Use</p>								<p>PAGE APPENDIX II</p>

REAR PROPERTY LINE

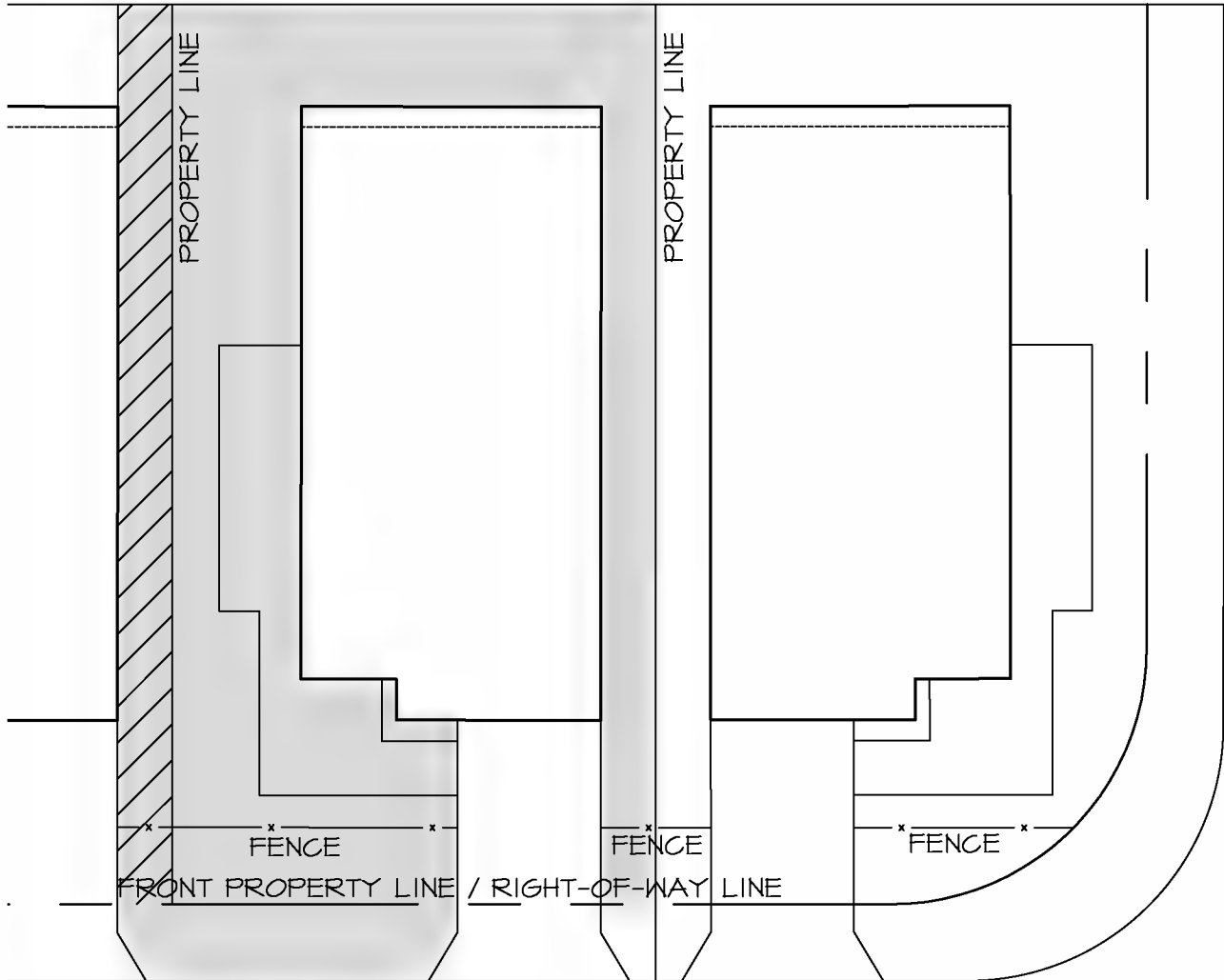

EDGE OF PAVEMENT



MAINTENANCE AND USE AREA

DOMINANT USE EASEMENT AREA

SPECIAL SIDE LIVING LOT MAINTENANCE AND USE EASEMENTS

ISSUE DATE 11-1-21

NOT TO SCALE

The Villages®

ARCHITECTURAL REVIEW POLICY & STANDARDS



REVISIONS

--	--	--	--	--	--	--	--

Patio Villa
Maintenance and Use Easements

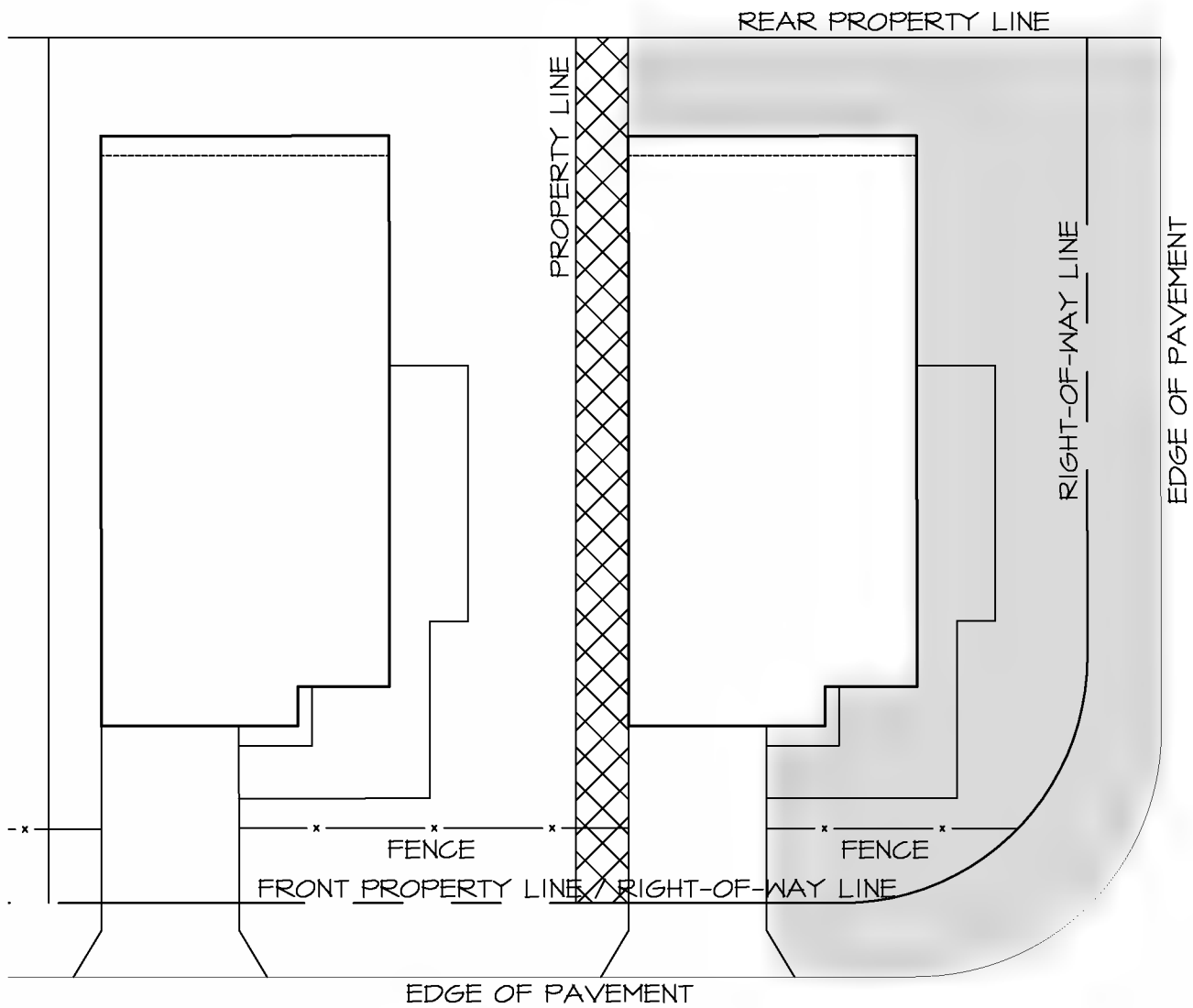
PAGE
APPENDIX II



-  MAINTENANCE AND USE AREA
-  SERVIENT USE EASEMENT AREA

CORNER SIDE LIVING LOT MAINTENANCE AND USE EASEMENTS

ISSUE DATE 11-1-21

NOT TO SCALE

 ARCHITECTURAL REVIEW POLICY & STANDARDS	REVISIONS								
	Patio Villa Maintenance and Use Easements								PAGE

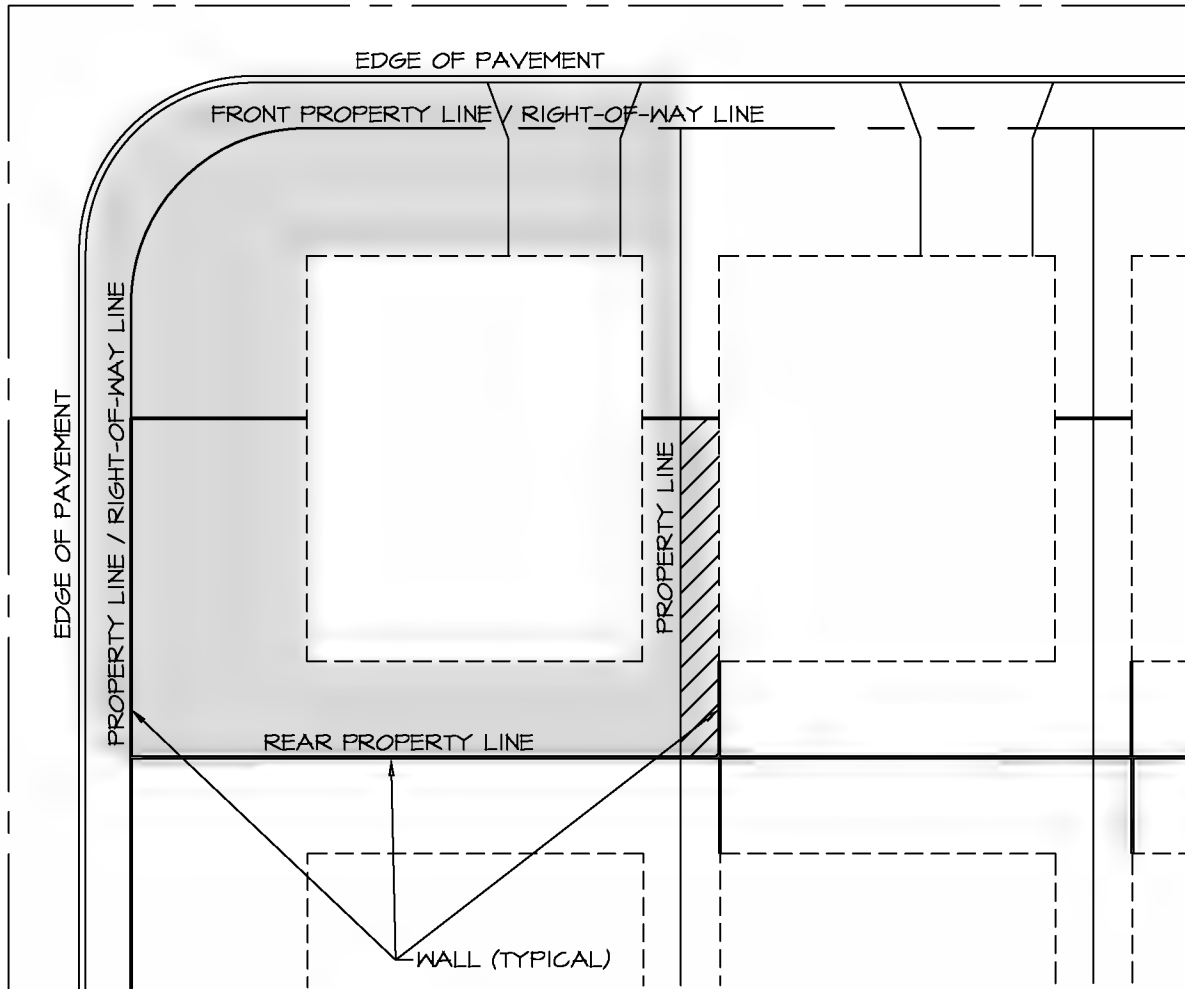
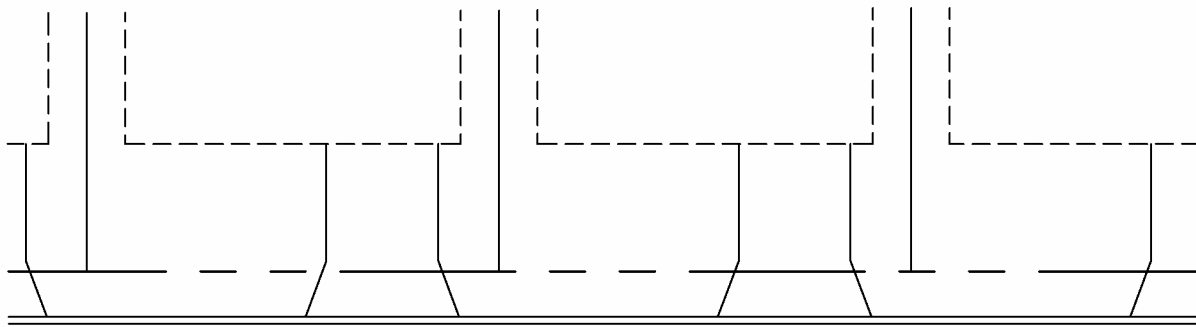

- MAINTENANCE AND USE AREA
- DOMINANT USE EASEMENT AREA



CORNER LOT MAINTENANCE AND USE EASEMENTS

ISSUE DATE 11-1-21

NOT TO SCALE

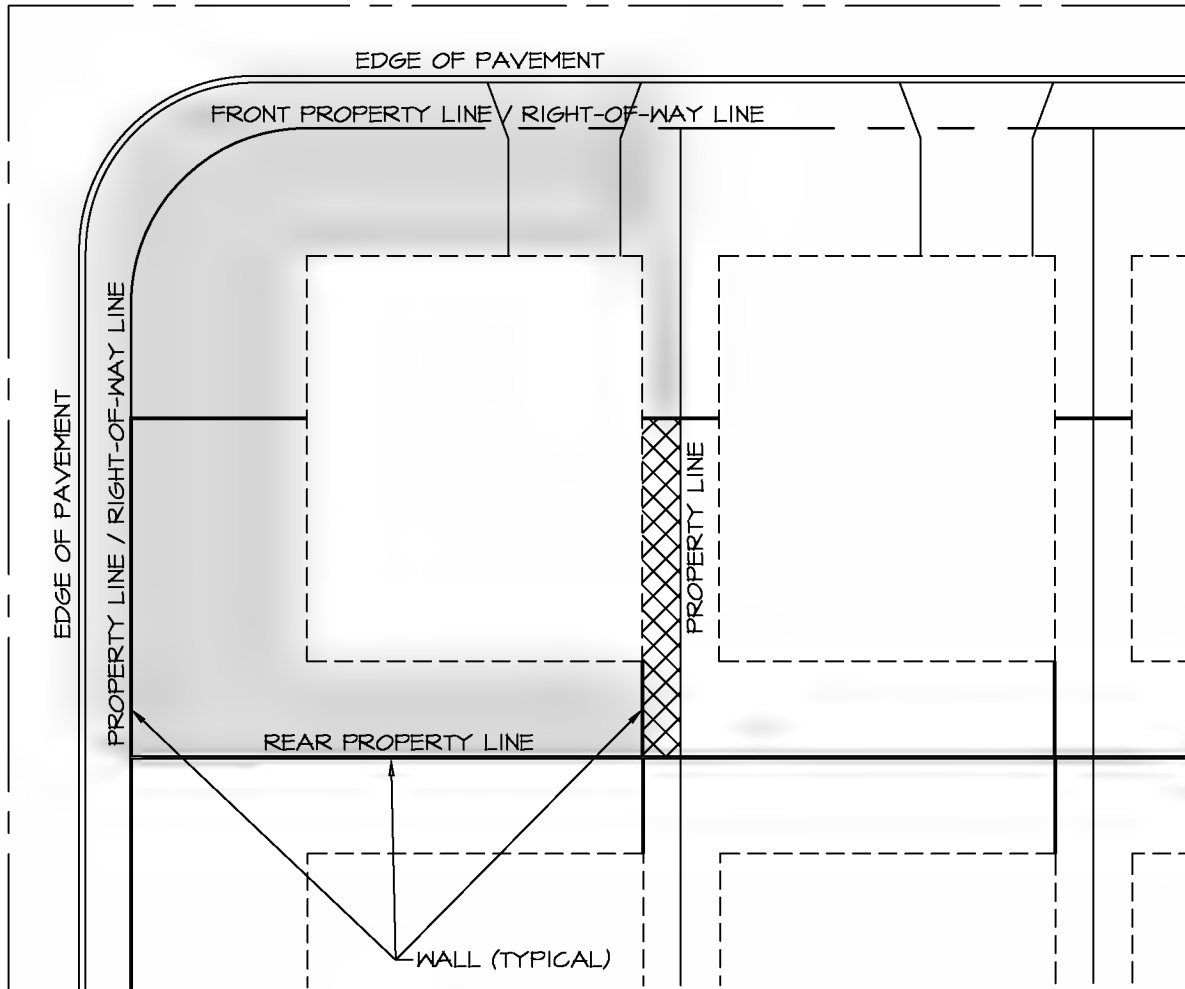
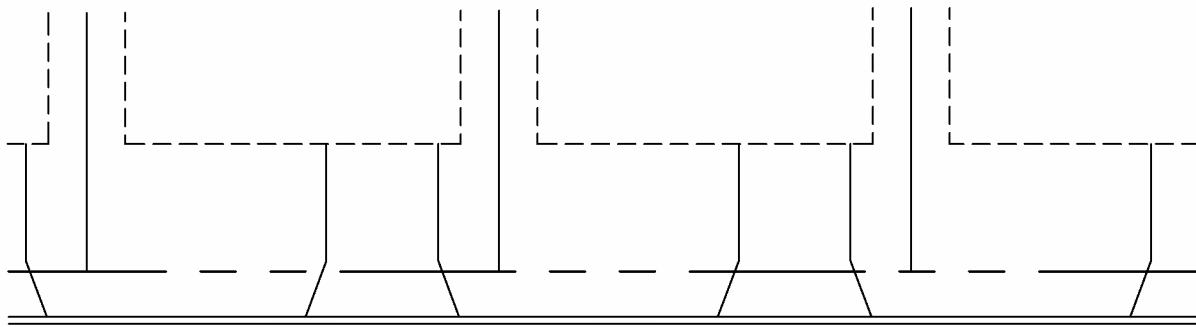
<p style="font-size: small; margin-top: 5px;">ARCHITECTURAL REVIEW POLICY & STANDARDS</p>	REVISIONS							
	<p style="font-size: large; margin: 0;"><i>Veranda Series</i></p> <p style="font-size: large; margin: 0;">Maintenance and Use Easements</p>							PAGE



-  MAINTENANCE AND USE AREA
-  SERVICENT USE EASEMENT AREA



CORNER LOT MAINTENANCE AND USE EASEMENTS

ISSUE DATE 11-1-21

NOT TO SCALE

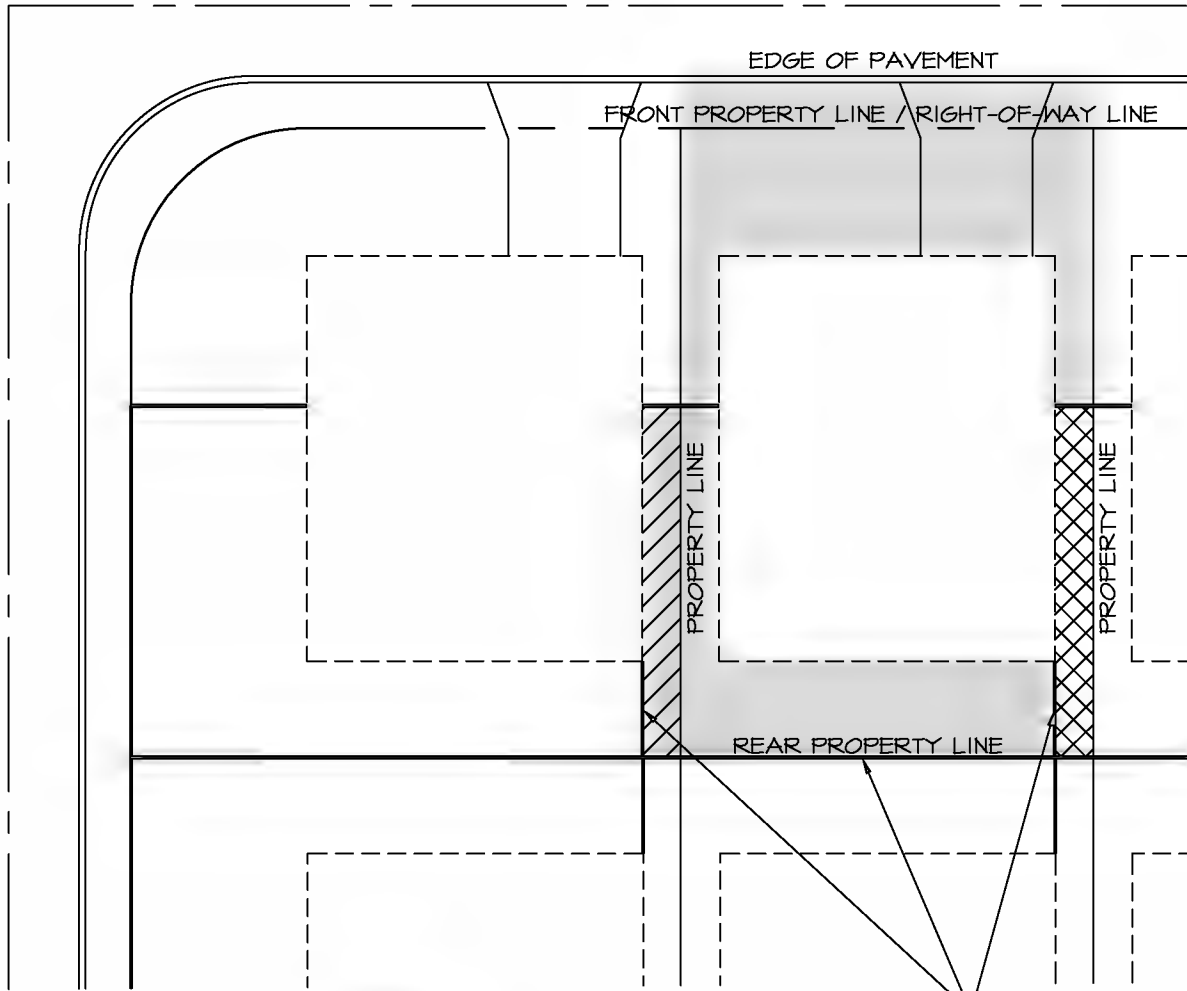
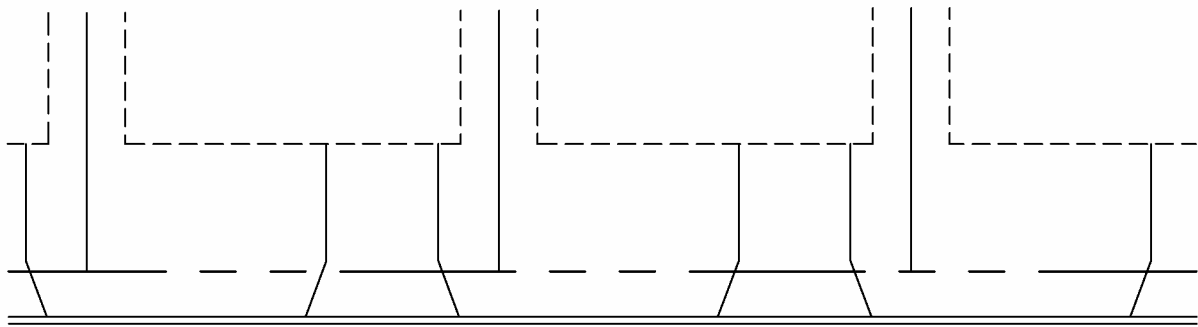
 ARCHITECTURAL REVIEW POLICY & STANDARDS	REVISIONS								
	Veranda Series Maintenance and Use Easements								PAGE APPENDIX III



-  MAINTENANCE AND USE AREA
-  DOMINANT USE EASEMENT AREA
-  SERVIENT USE EASEMENT AREA

STANDARD LOT MAINTENANCE AND USE EASEMENTS

ISSUE DATE 11-1-21

NOT TO SCALE

 ARCHITECTURAL REVIEW POLICY & STANDARDS	REVISIONS								
	Veranda Series Maintenance and Use Easements								PAGE

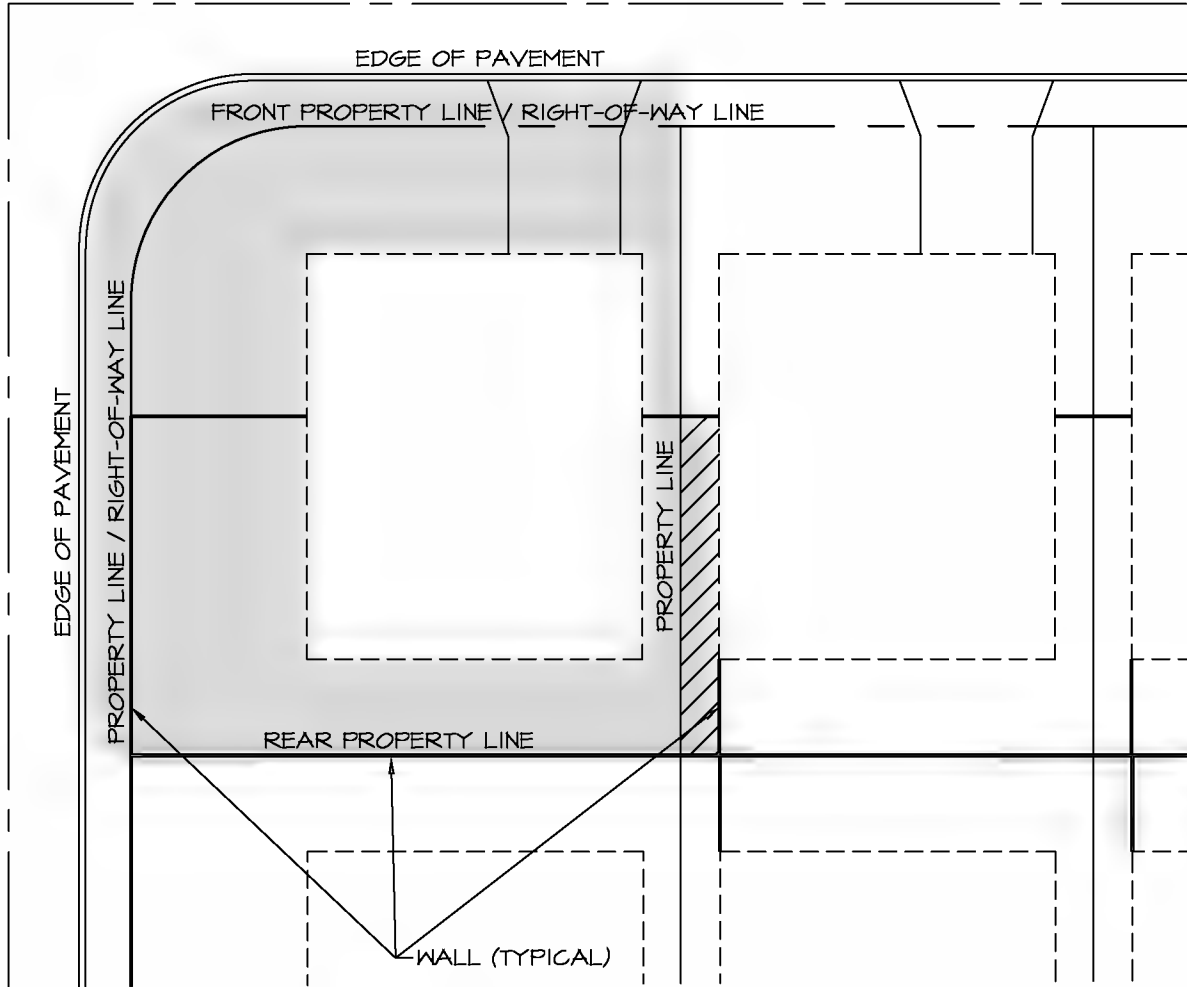
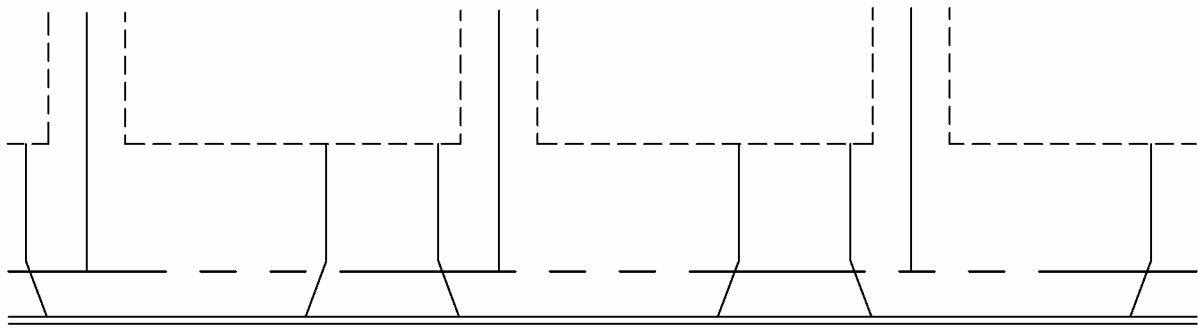

- MAINTENANCE AND USE AREA
- DOMINANT USE EASEMENT AREA

CORNER LOT MAINTENANCE AND USE EASEMENTS

ISSUE DATE 11-1-21

NOT TO SCALE

<p>ARCHITECTURAL REVIEW POLICY & STANDARDS</p>	REVISIONS							
	<p>Cottage Villa Maintenance and Use Easements</p>							PAGE

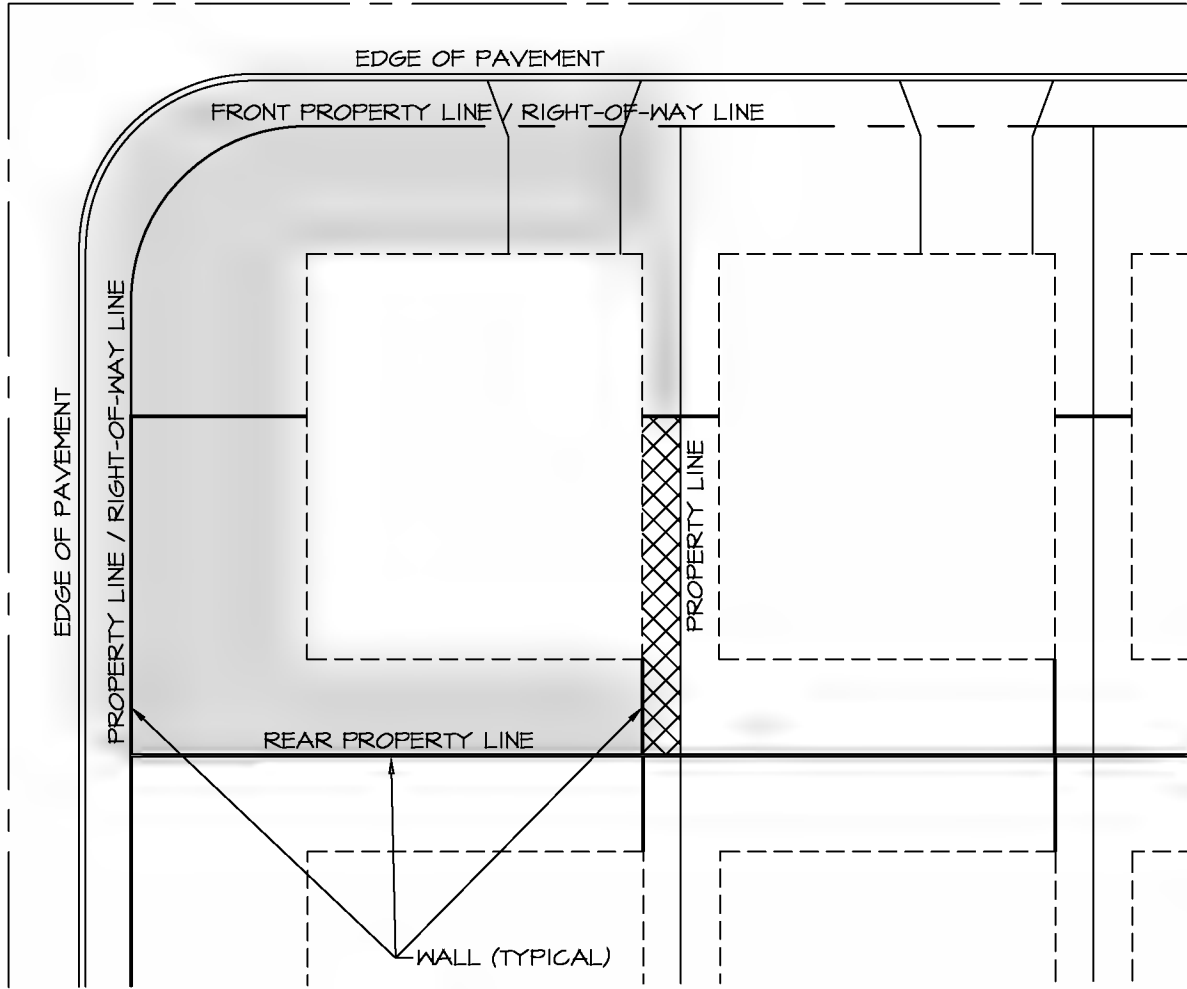
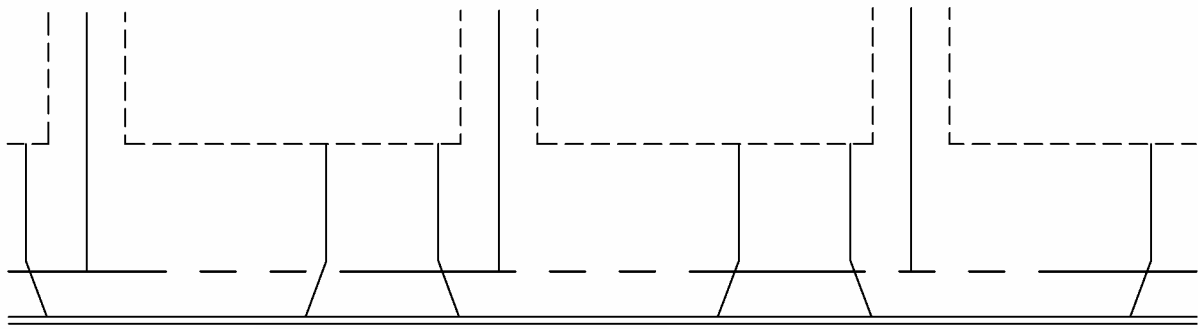

- MAINTENANCE AND USE AREA
- SERVIENT USE EASEMENT AREA

CORNER LOT MAINTENANCE AND USE EASEMENTS

ISSUE DATE 11-1-21

NOT TO SCALE

 ARCHITECTURAL REVIEW POLICY & STANDARDS	REVISIONS								
	Cottage Villa Maintenance and Use Easements								PAGE

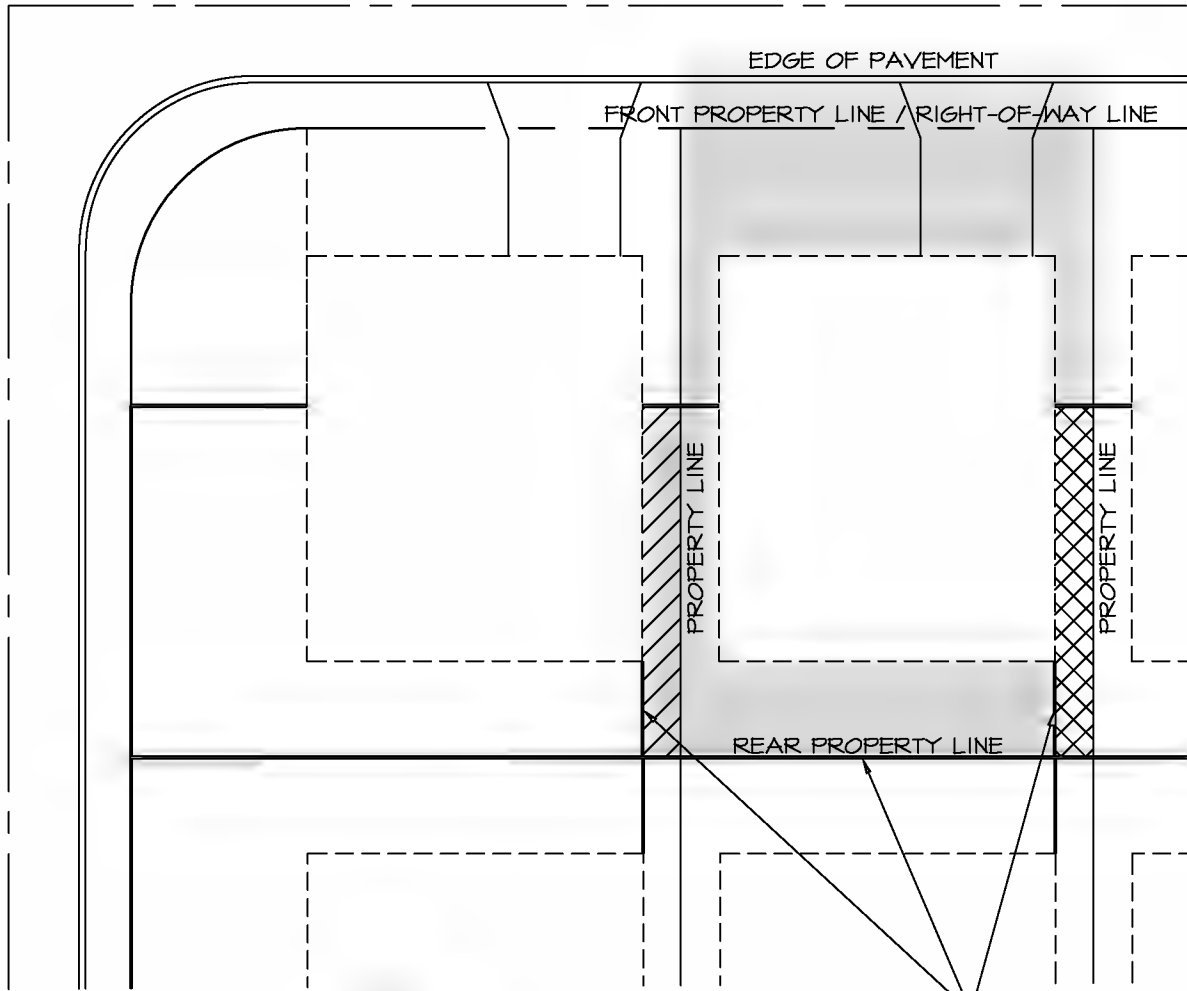
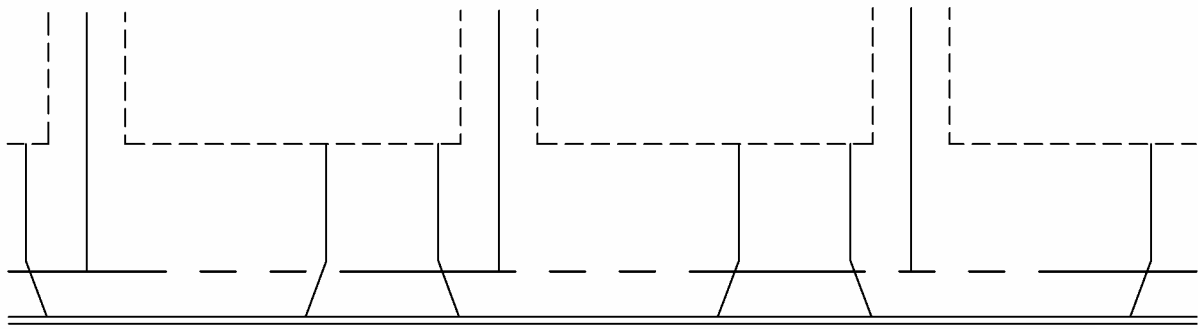

- MAINTENANCE AND USE AREA
- DOMINANT USE EASEMENT AREA
- SERVIENT USE EASEMENT AREA

STANDARD LOT MAINTENANCE AND USE EASEMENTS

ISSUE DATE 11-1-21

NOT TO SCALE

<p>ARCHITECTURAL REVIEW POLICY & STANDARDS</p>	REVISIONS							
	<p>Cottage Villa Maintenance and Use Easements</p>							PAGE

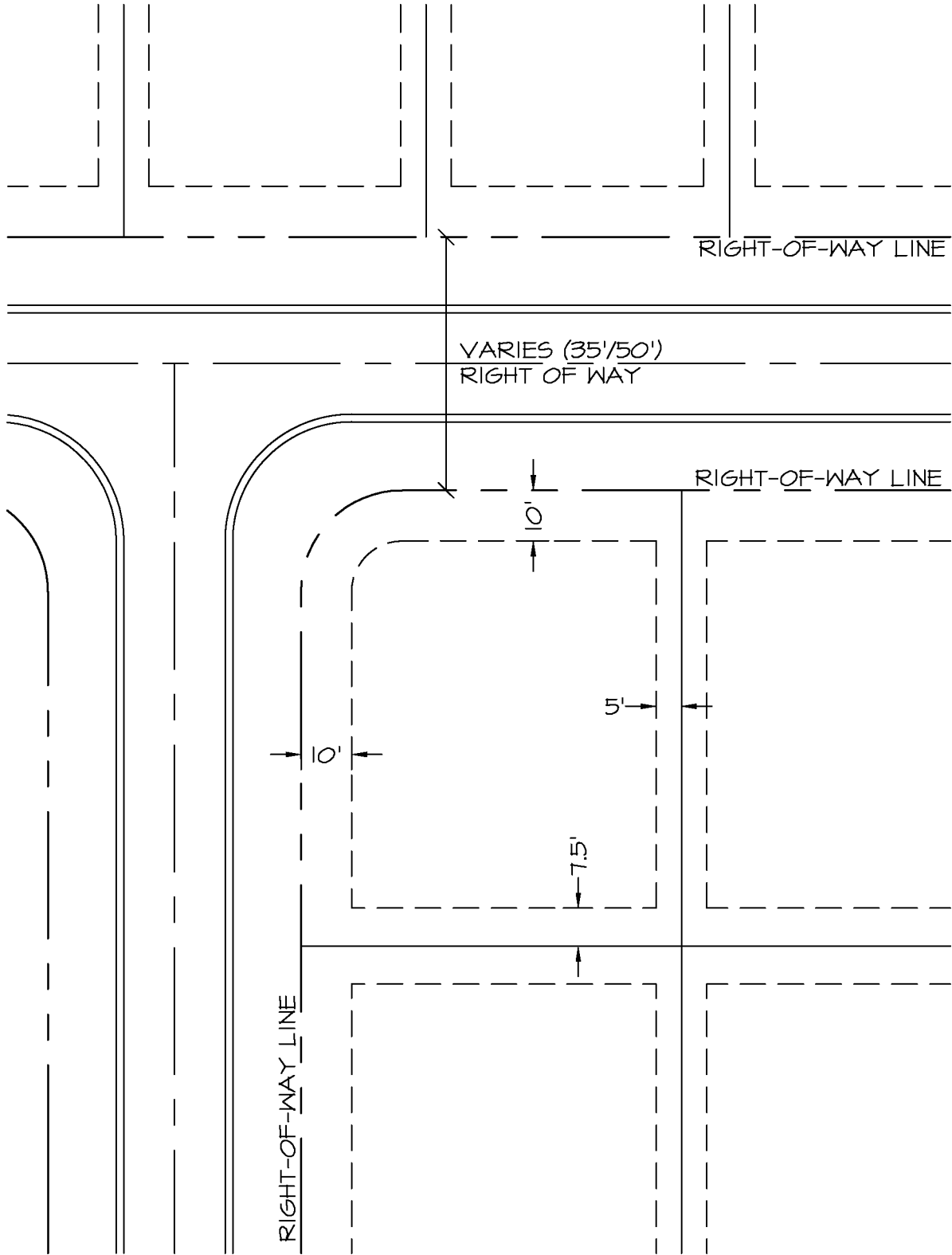

ISSUE DATE 11-1-21

NOT TO SCALE

The Villages®

ARCHITECTURAL REVIEW POLICY & STANDARDS

REVISIONS

Utility Easements
Standard & Cottage Home

PAGE

APPENDIX V

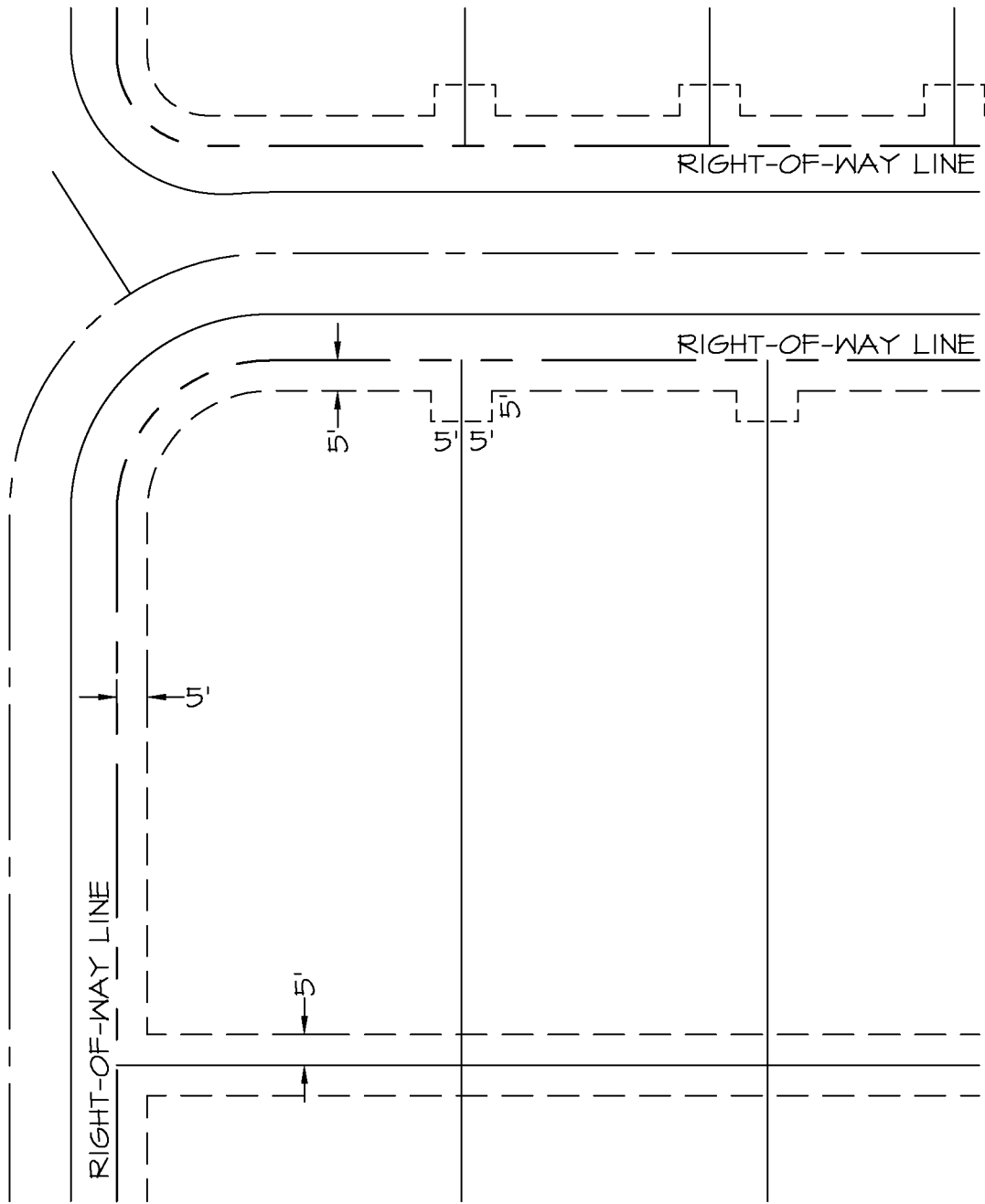

ISSUE DATE 11-1-21

NOT TO SCALE

 <p>ARCHITECTURAL REVIEW POLICY & STANDARDS</p>	REVISIONS								
	<p>Utility Easements Courtyard Villa</p>								<p>PAGE APPENDIX V</p>

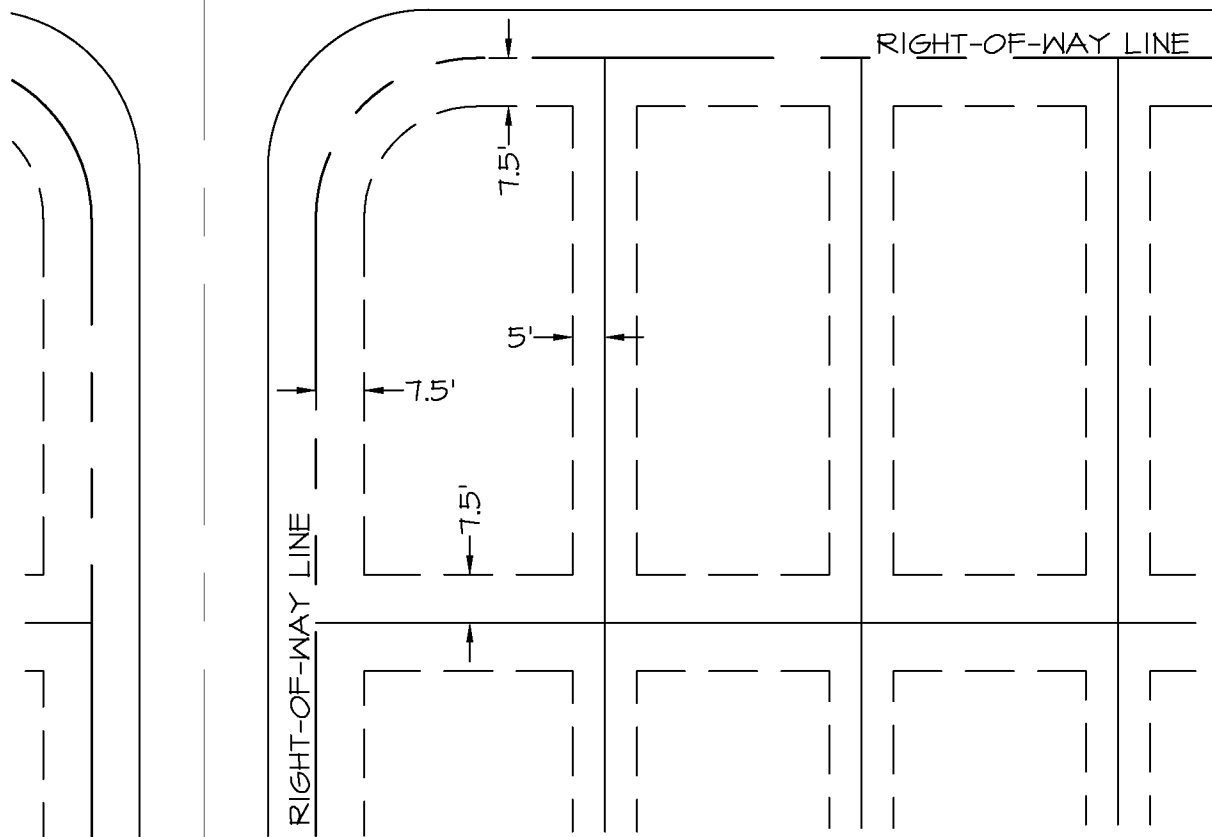
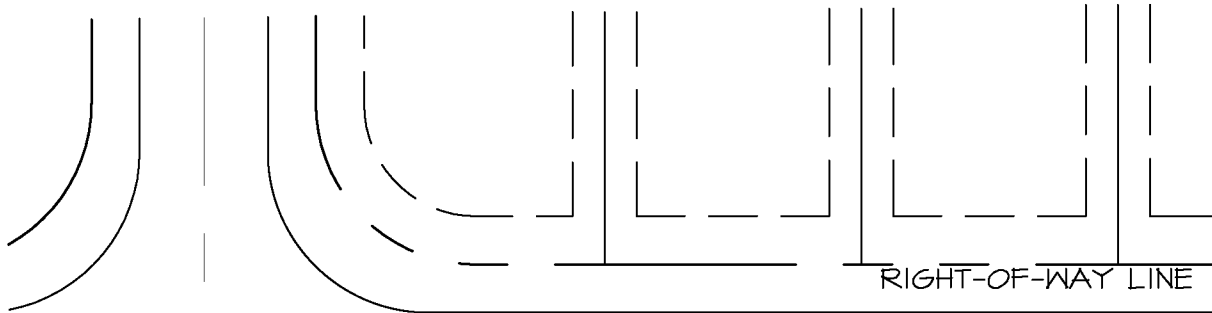

ISSUE DATE 11-1-21

NOT TO SCALE

The Villages®

ARCHITECTURAL REVIEW POLICY & STANDARDS

REVISIONS

Utility Easements
Patio Villa

PAGE
APPENDIX V

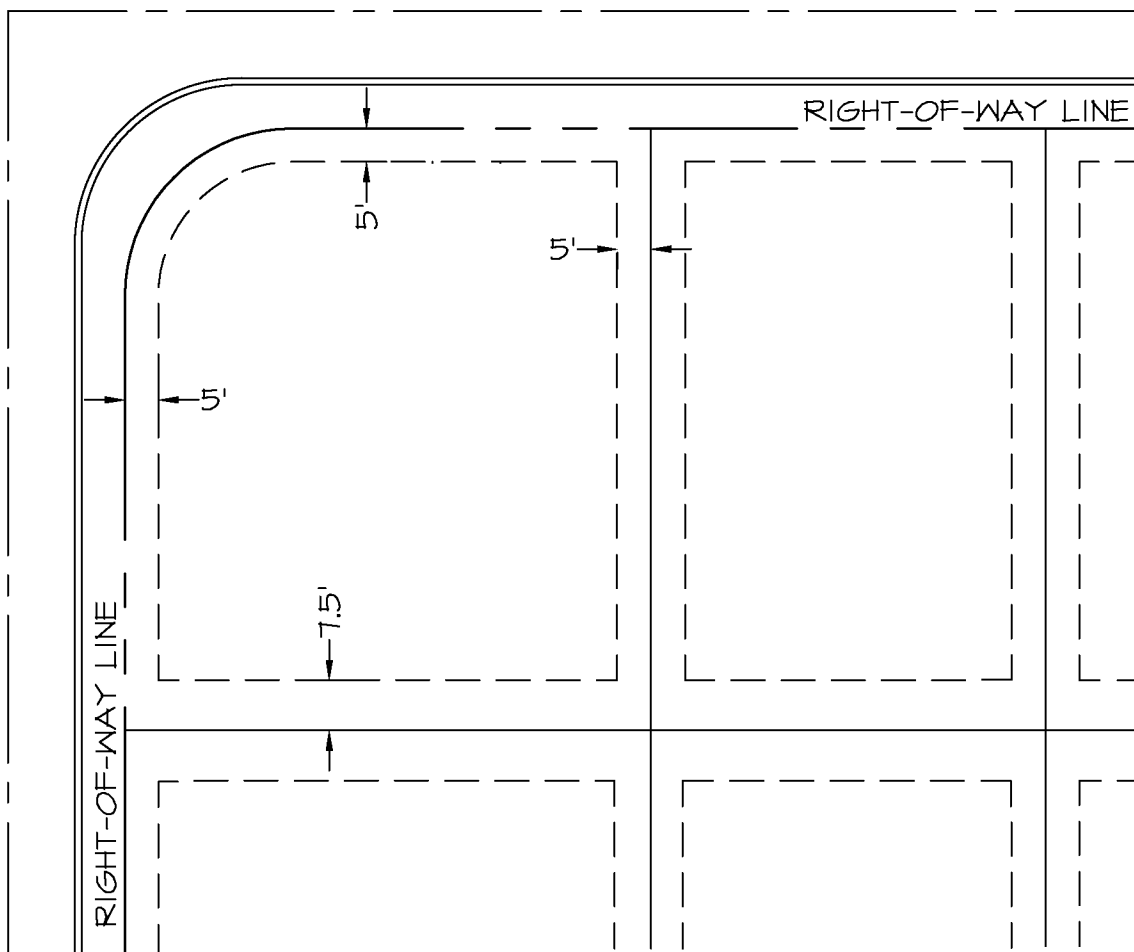
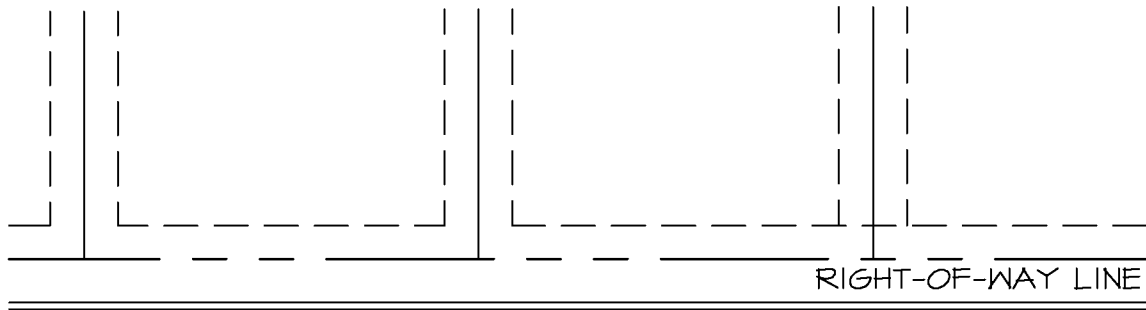

ISSUE DATE 11-1-21

NOT TO SCALE

The Villages®

ARCHITECTURAL REVIEW POLICY & STANDARDS

REVISIONS

Utility Easements
Veranda Series

PAGE
APPENDIX V

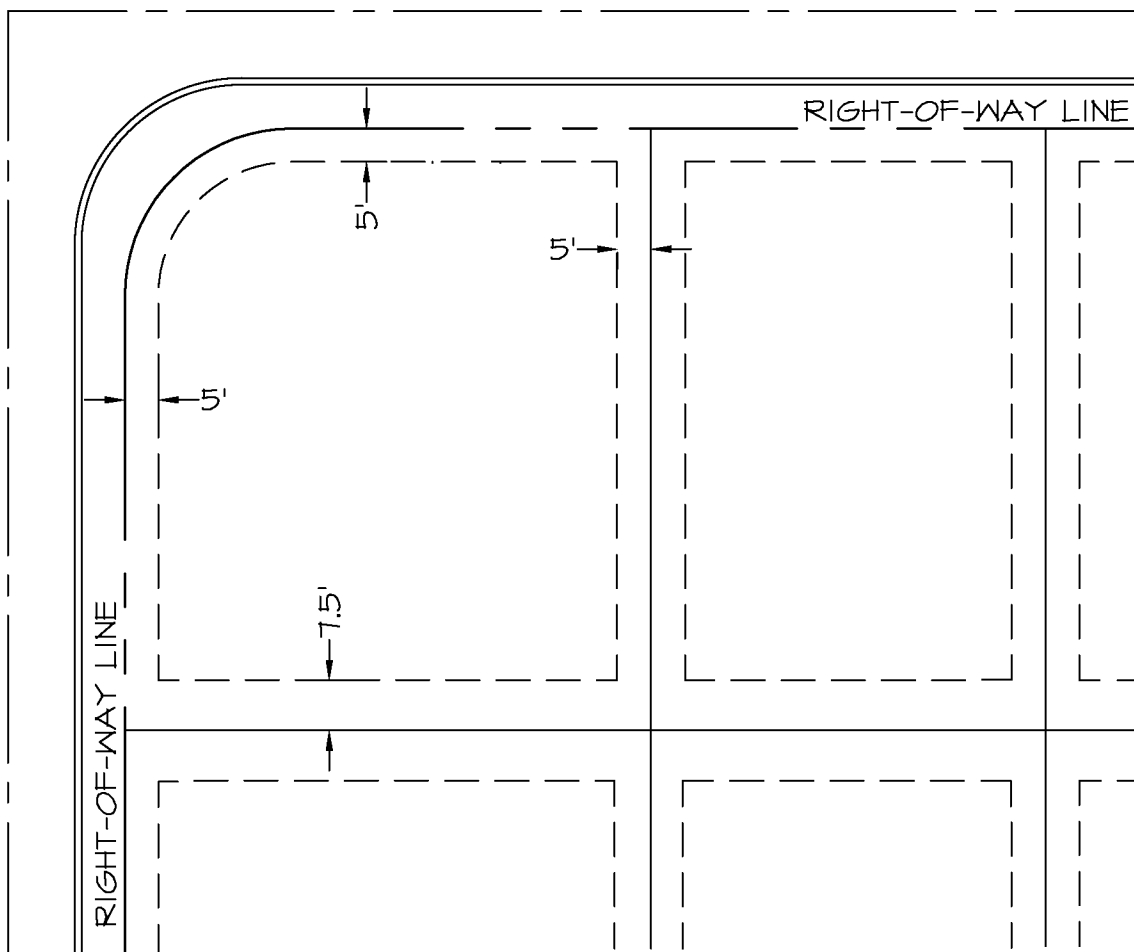
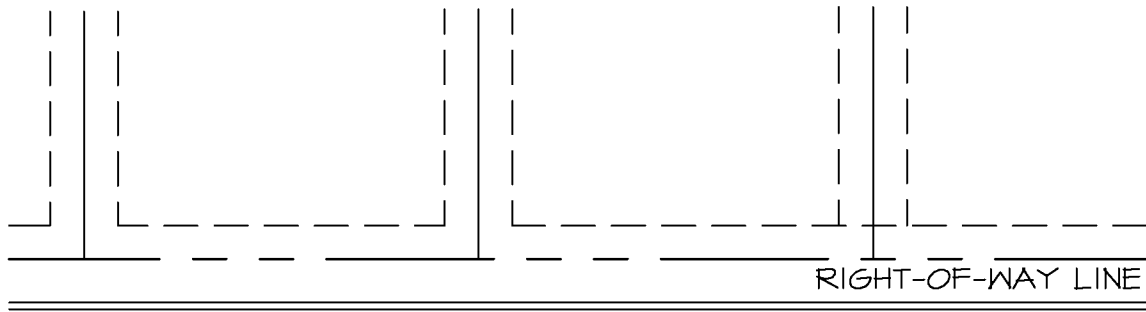

ISSUE DATE 11-1-21

NOT TO SCALE

 <p>ARCHITECTURAL REVIEW POLICY & STANDARDS</p>	REVISIONS								
	<p>Utility Easements Cottage Villa</p>								<p>PAGE APPENDIX V</p>

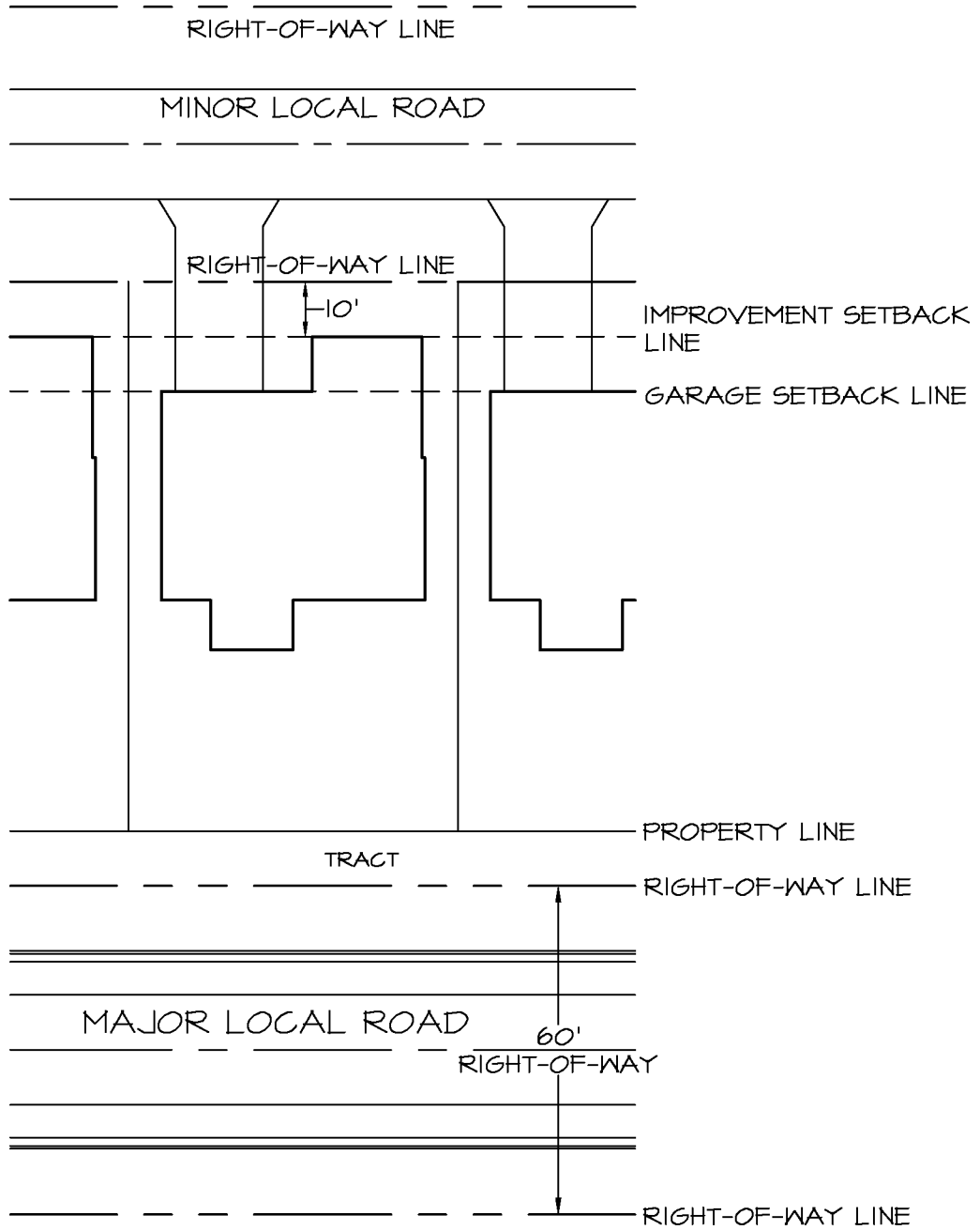

ISSUE DATE 11-1-21

NOT TO SCALE

 <p>ARCHITECTURAL REVIEW POLICY & STANDARDS</p>	<p>REVISIONS</p> <table border="1"> <tr> <td> </td> <td> </td> <td> </td> <td> </td> <td> </td> <td> </td> <td> </td> </tr> </table>								<p>PAGE</p> <p>APPENDIX VI</p>
<p>Local Government Road Setbacks</p> <p>Double Frontage Home Minor Local Road</p>									

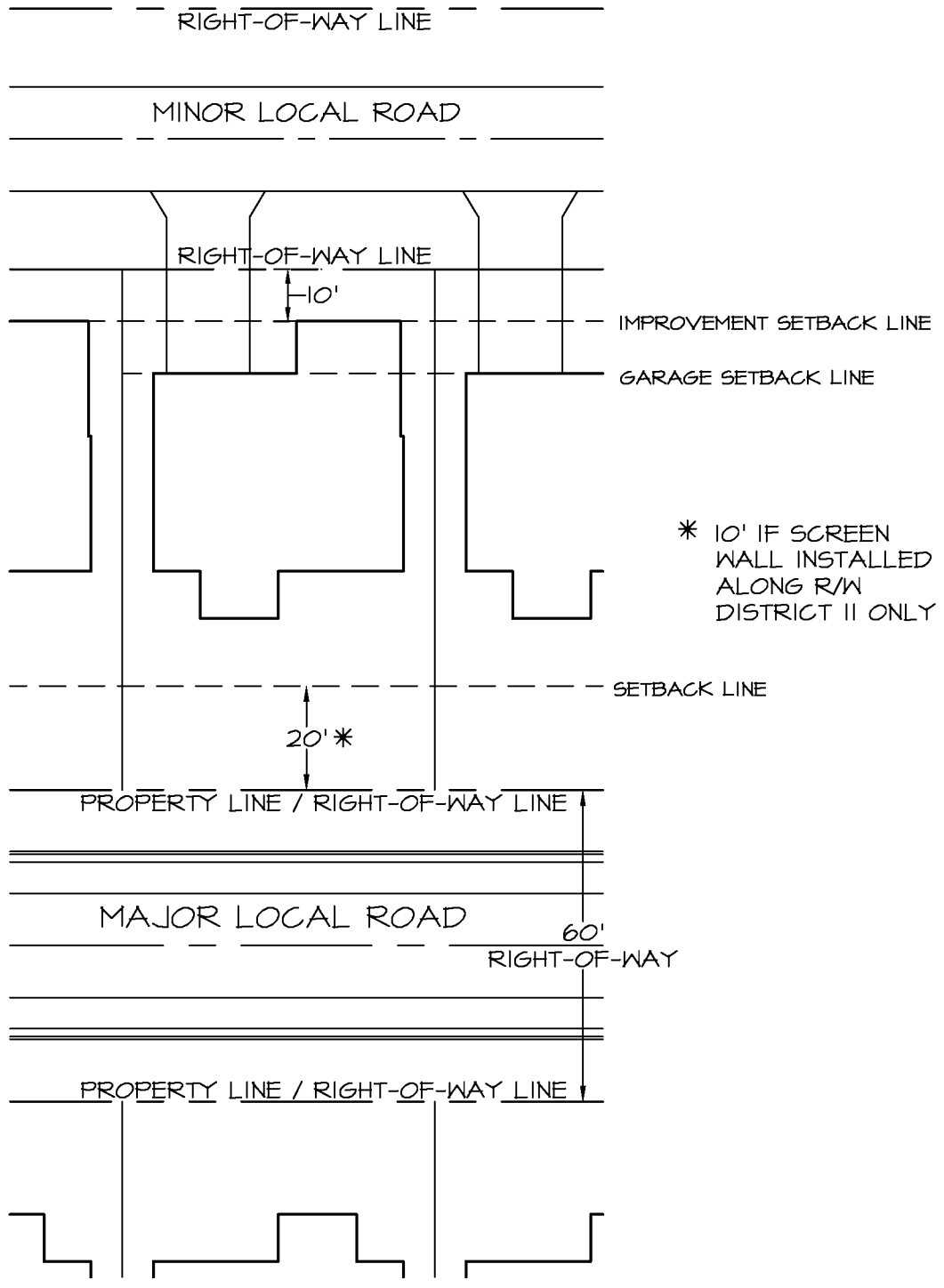

ISSUE DATE 11-1-21

NOT TO SCALE

 <p>ARCHITECTURAL REVIEW POLICY & STANDARDS</p>	<p>REVISIONS</p> <table border="1"> <tr> <td> </td> <td> </td> <td> </td> <td> </td> <td> </td> <td> </td> <td> </td> </tr> </table>								<p>PAGE</p> <p>APPENDIX VI</p>
<p>Local Government Road Setbacks</p> <p>Double Frontage Home Major Local Road</p>									

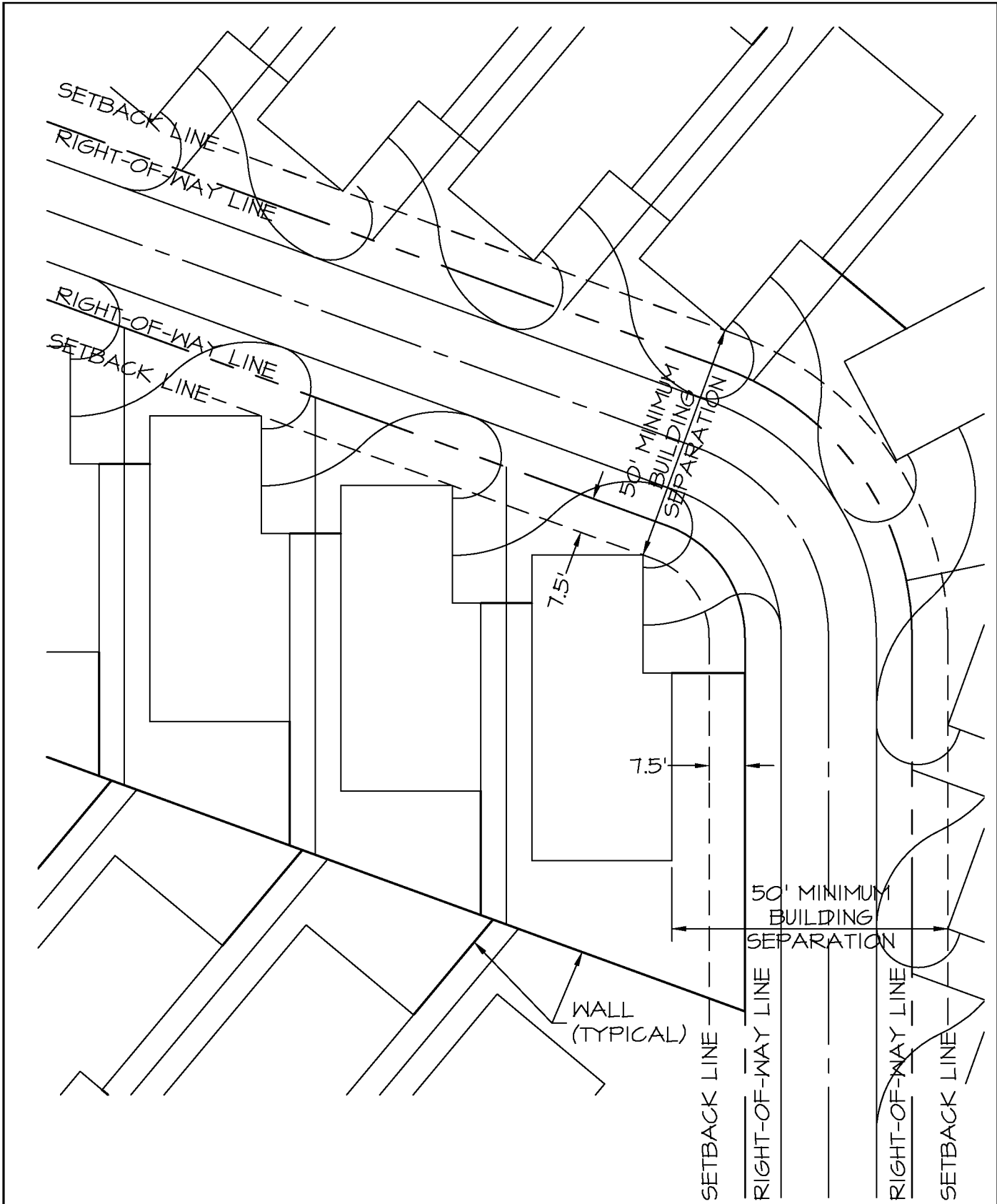

ISSUE DATE 06-01-15

NOT TO SCALE

 <p>ARCHITECTURAL REVIEW POLICY & STANDARDS</p>	REVISIONS								
	Local Government Road Setbacks Courtyard Villa								PAGE APPENDIX VI

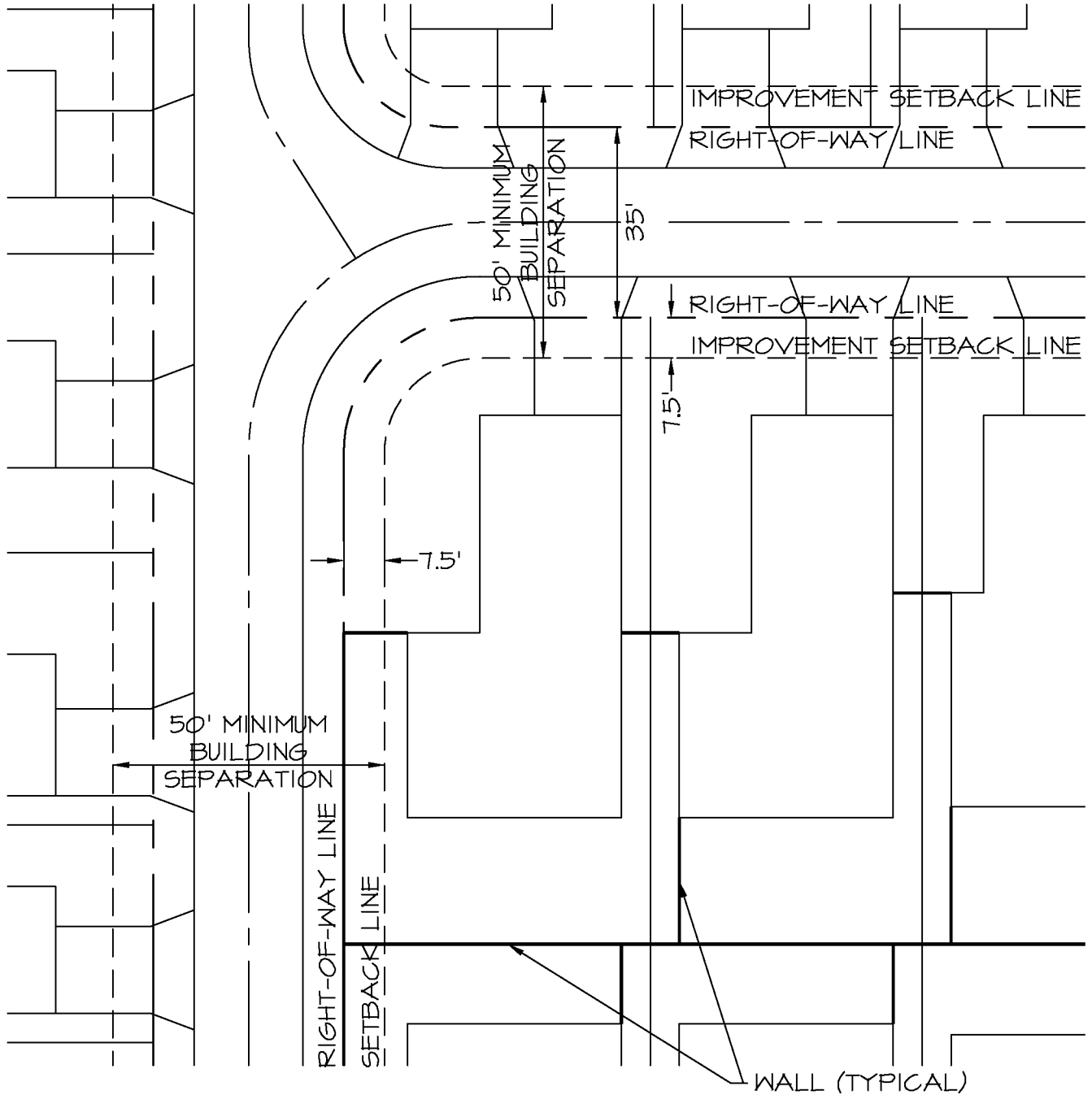

ISSUE DATE 11-1-21

NOT TO SCALE

The Villages

ARCHITECTURAL REVIEW POLICY & STANDARDS

REVISIONS

Local Government Road Setbacks
Courtyard Villa

PAGE
APPENDIX VI

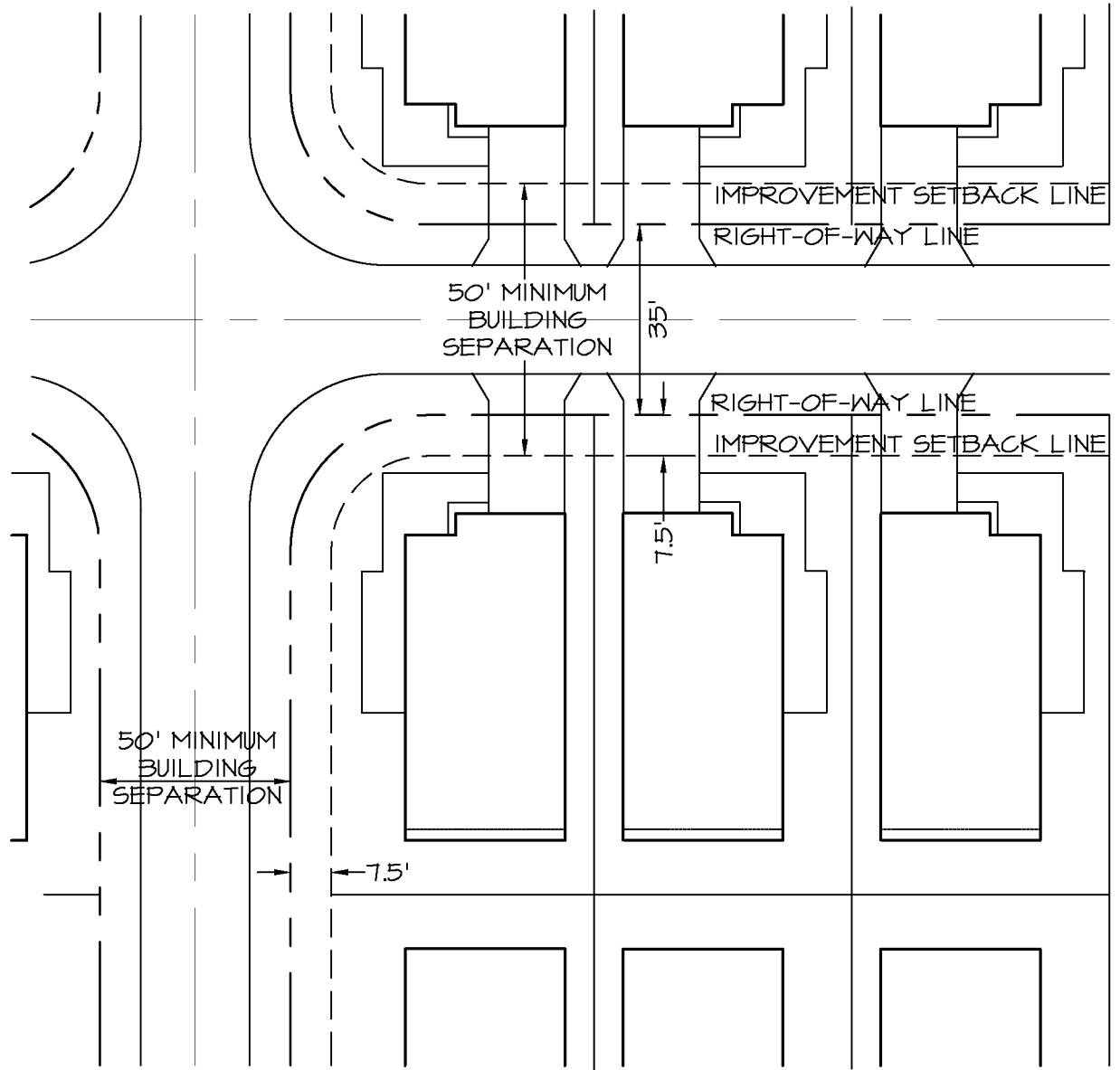

ISSUE DATE 11-1-21

NOT TO SCALE

 <p>ARCHITECTURAL REVIEW POLICY & STANDARDS</p>	<p>REVISIONS</p> <table border="1"> <tr> <td> </td> <td> </td> <td> </td> <td> </td> <td> </td> <td> </td> <td> </td> </tr> </table>								<p>PAGE</p> <p>APPENDIX VI</p>
<p>Local Government Road Setbacks</p> <p>Patio Villa Lot</p>									

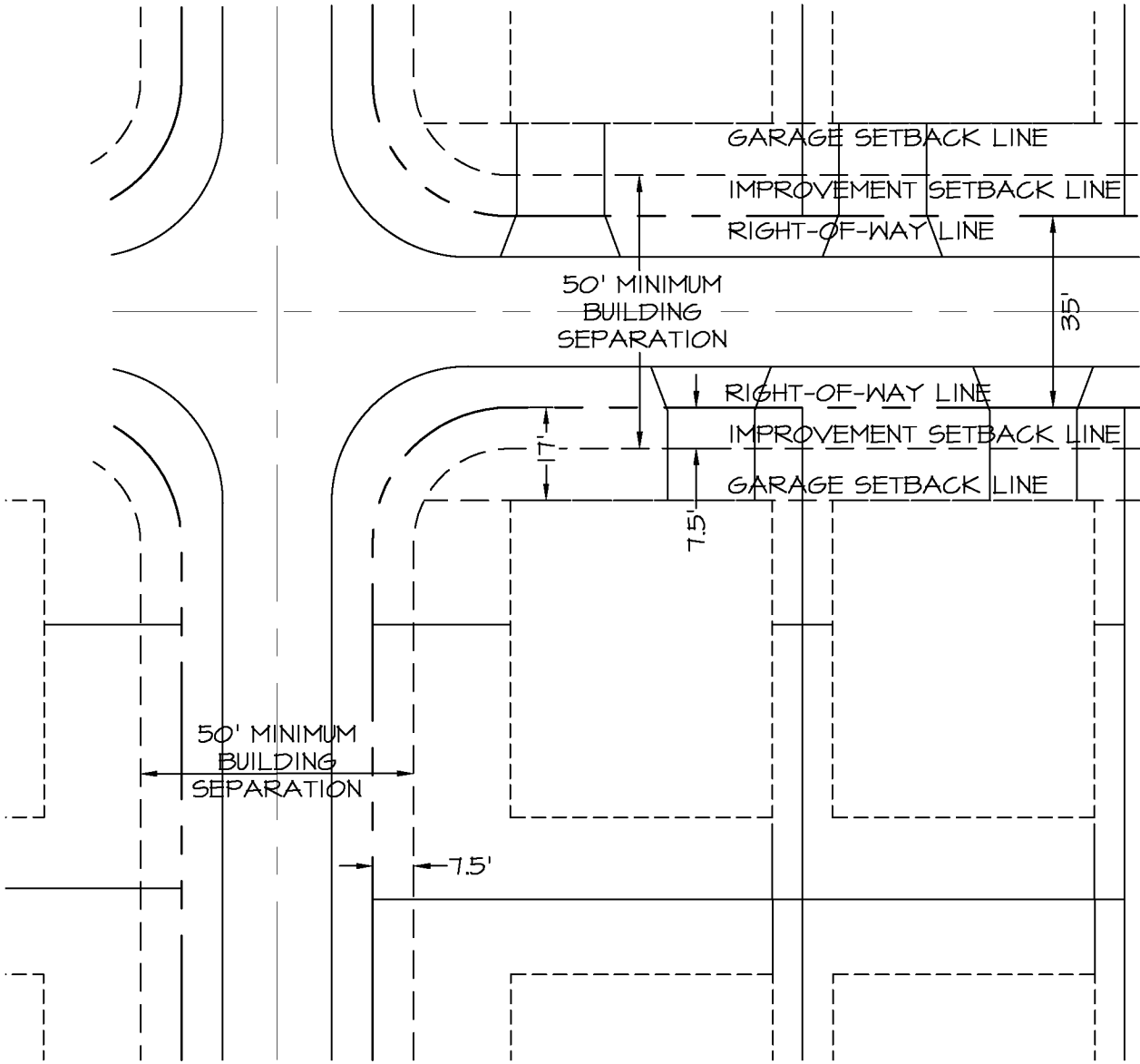

ISSUE DATE 11-1-21

NOT TO SCALE

 <p>ARCHITECTURAL REVIEW POLICY & STANDARDS</p>	<p>REVISIONS</p> <table border="1"> <tr> <td> </td> <td> </td> <td> </td> <td> </td> <td> </td> <td> </td> <td> </td> </tr> </table>								<p>PAGE</p> <p>APPENDIX VI</p>
<p>Local Government Road Setbacks Veranda Series Lot</p>									

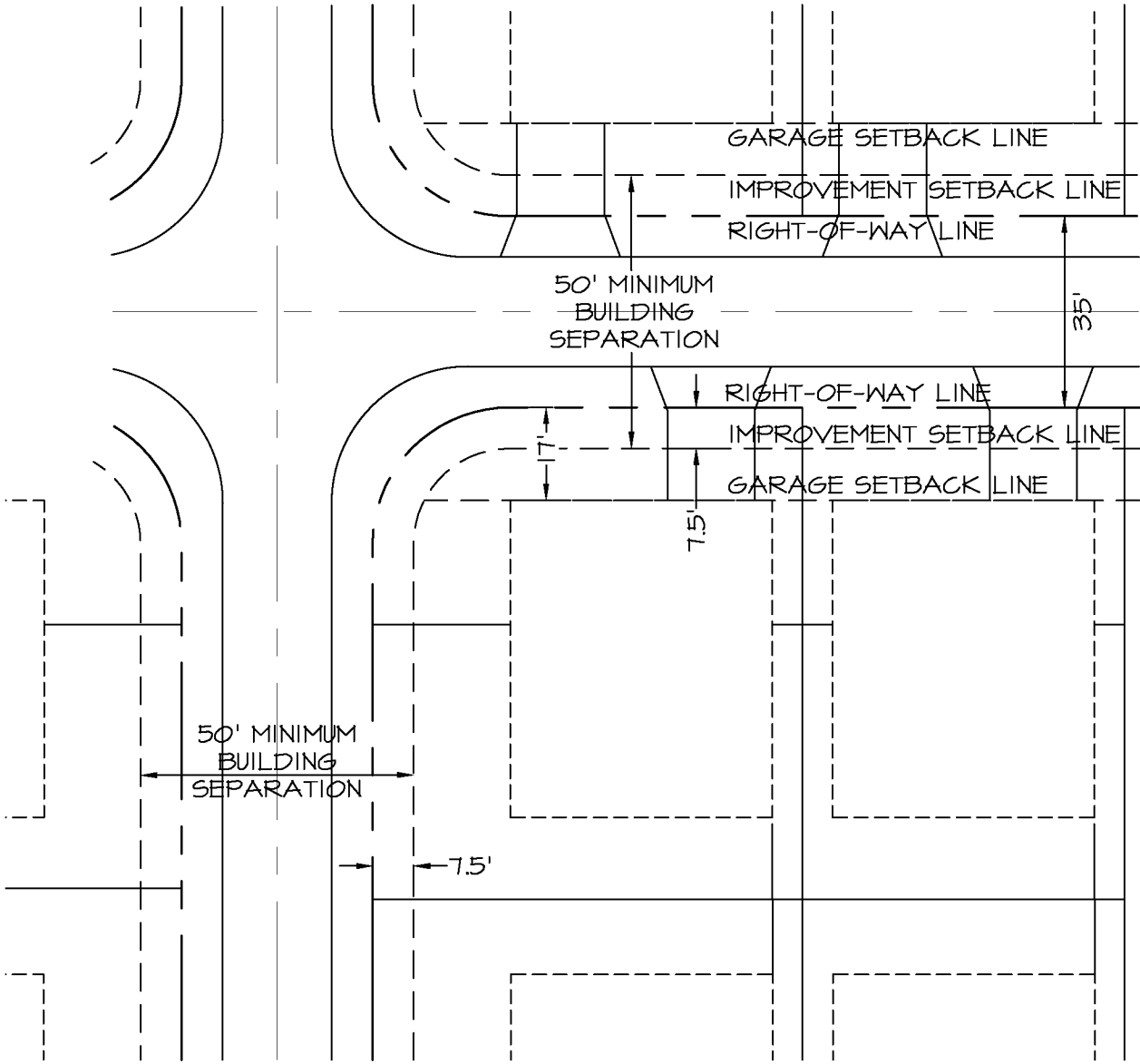

ISSUE DATE 11-1-21

NOT TO SCALE

 <p>ARCHITECTURAL REVIEW POLICY & STANDARDS</p>	<p>REVISIONS</p> <table border="1"> <tr> <td> </td> <td> </td> <td> </td> <td> </td> <td> </td> <td> </td> <td> </td> <td> </td> </tr> </table>									<p>PAGE</p> <p>APPENDIX VI</p>
<p>Local Government Road Setbacks Cottage Villa Lot</p>										

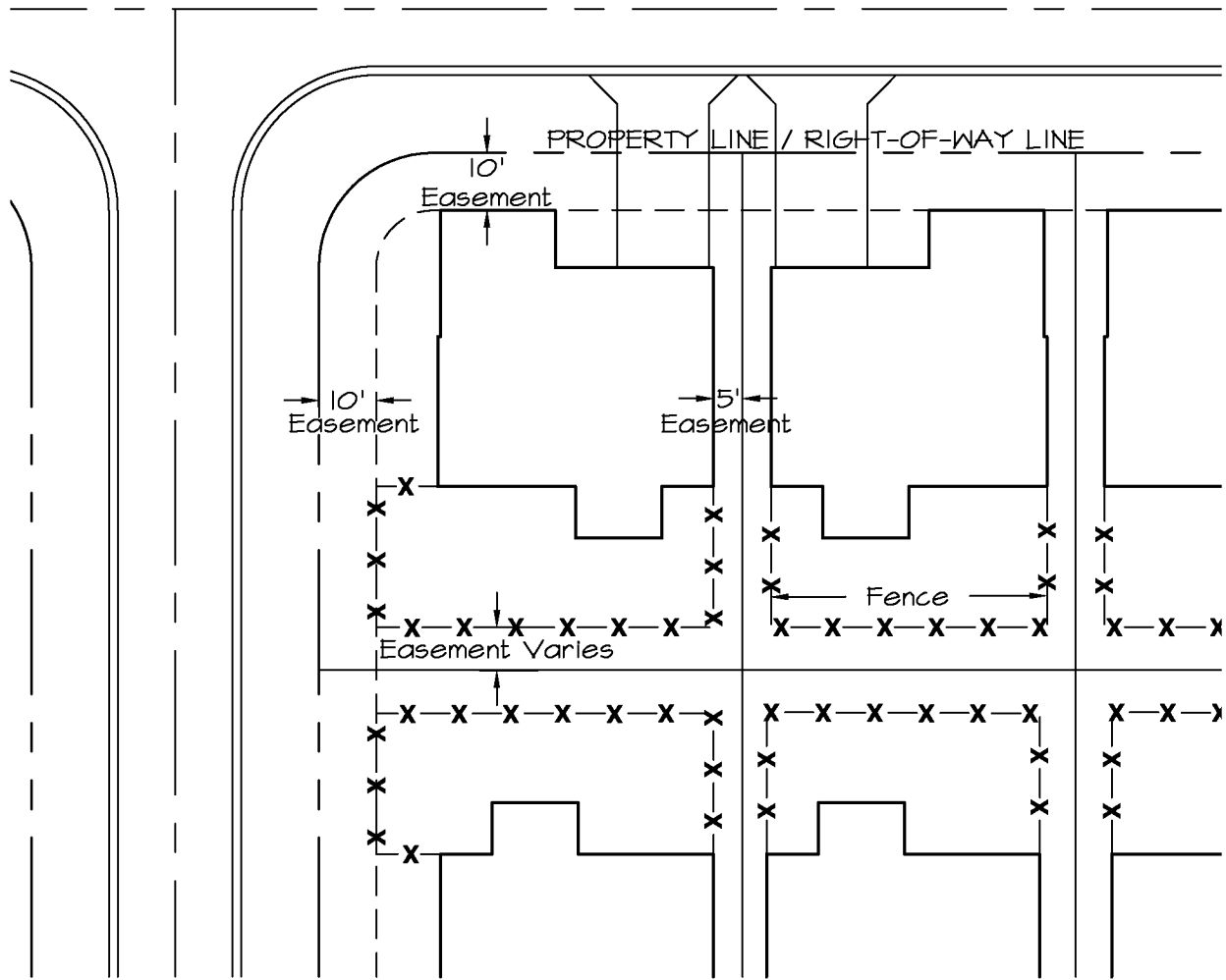
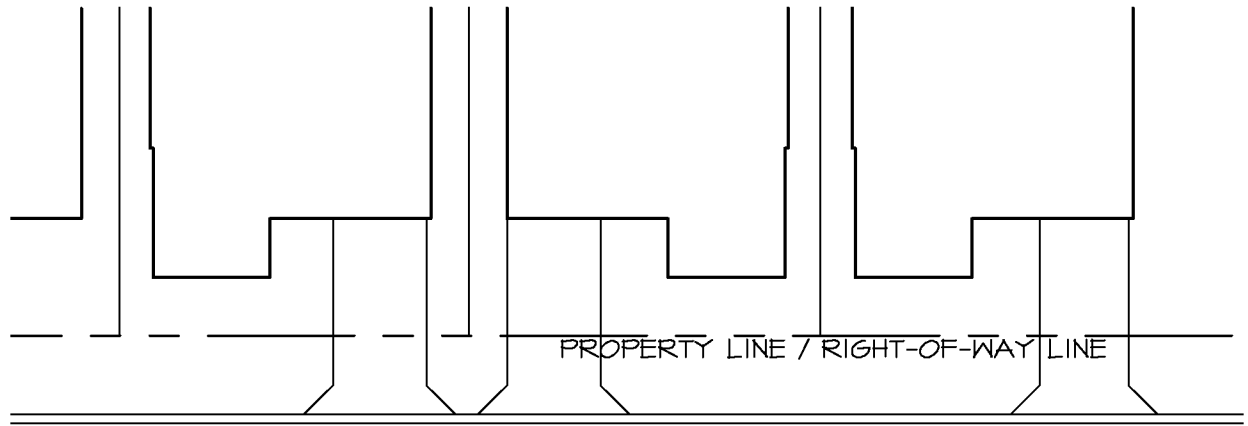

Note:
 1) Fences are permitted in the rear yard only and must not encroach any utility or use easement
 2) All fences must be 36" closed top picket fence, 1-1/2" picket, 3" spacing and double 36" gate to exterior, color: weathered aspen
 National Vinyl Products is who provides this product

ISSUE DATE 12-22-21

NOT TO SCALE

 ARCHITECTURAL REVIEW POLICY & STANDARDS	REVISIONS								
	District 13 VOSO Unit 46 Fences								PAGE APPENDIX VII





ISSUE DATE 12-22-21

NOT TO SCALE

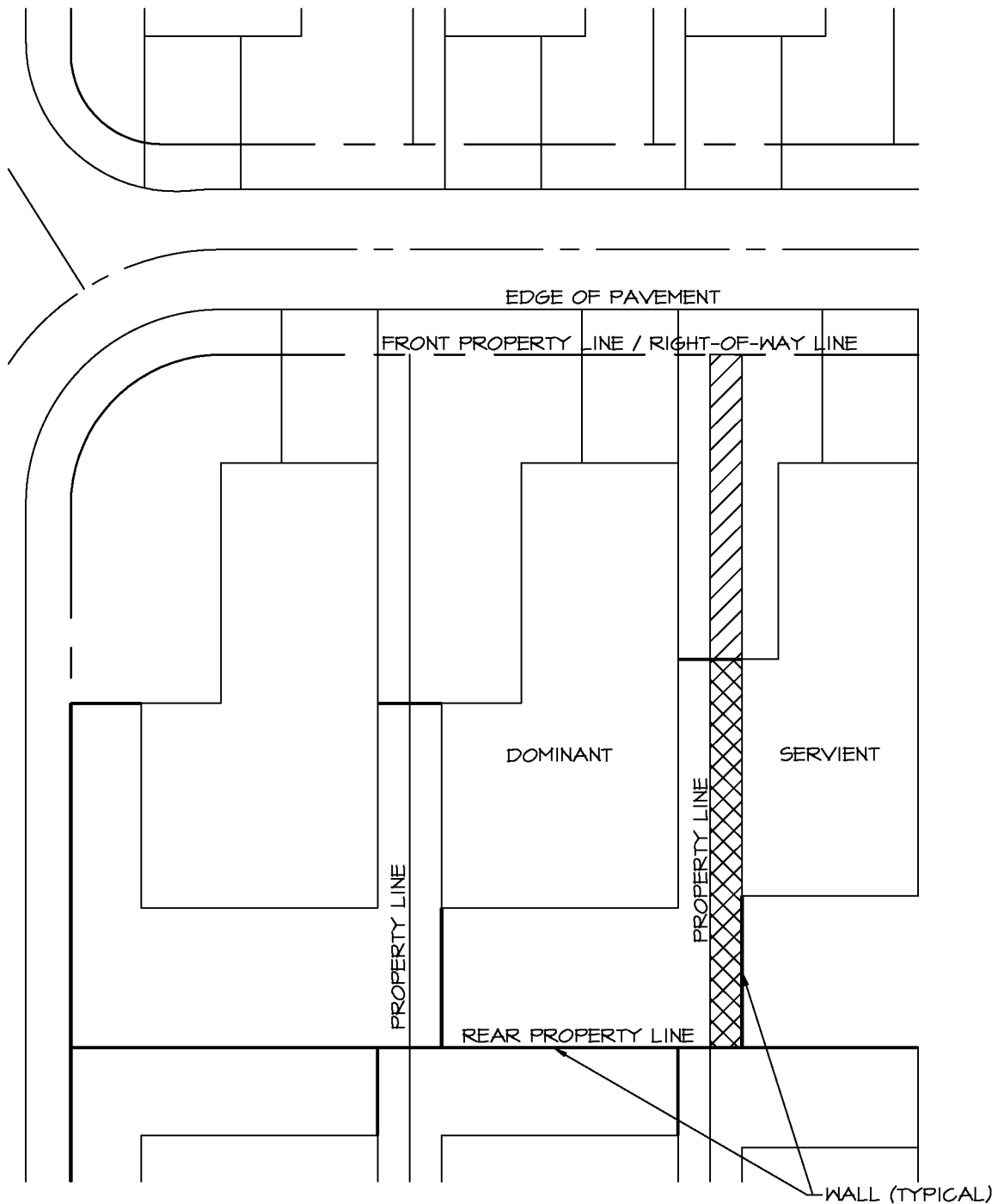
The Villages ARCHITECTURAL REVIEW POLICY & STANDARDS	REVISIONS								
	36" Closed Top Picket Fence								PAGE



-  FRONT SIDE YARD EASEMENT
-  REAR SIDE YARD EASEMENT



STANDARD LOT "FRONT LOAD"
FRONT & REAR SIDE EASEMENTS

ISSUE DATE 5-1-22

NOT TO SCALE

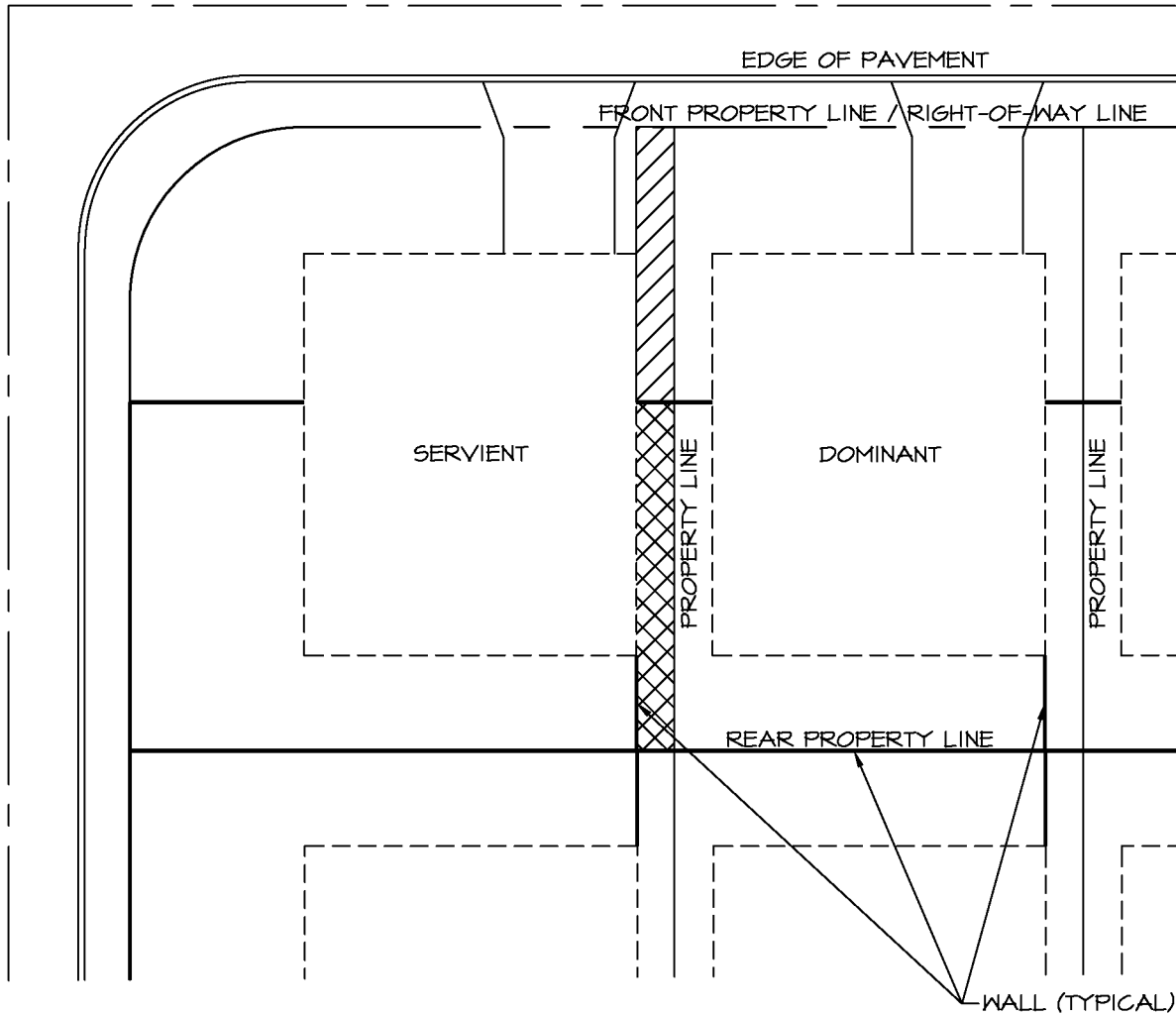
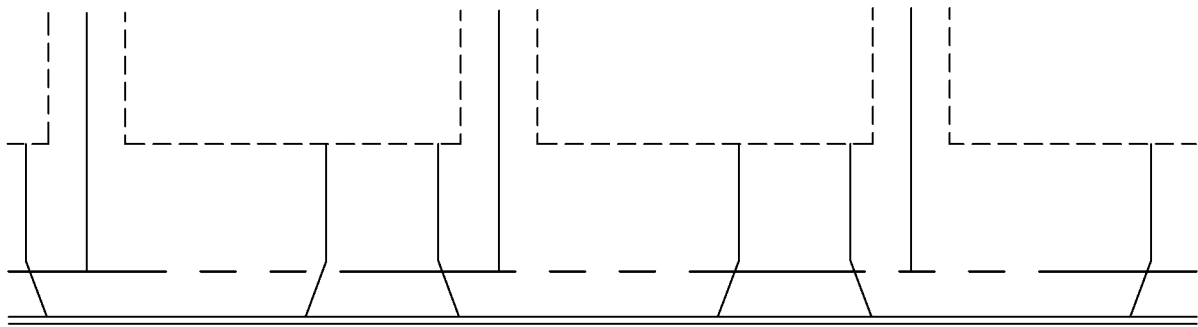
 ARCHITECTURAL REVIEW POLICY & STANDARDS	REVISIONS								
	Courtyard Villa Front & Rear Side Yard Easements								PAGE



-  FRONT SIDE YARD EASEMENT
-  REAR SIDE YARD EASEMENT



STANDARD LOT
FRONT & REAR SIDE YARD EASEMENTS

ISSUE DATE 5-1-22

NOT TO SCALE

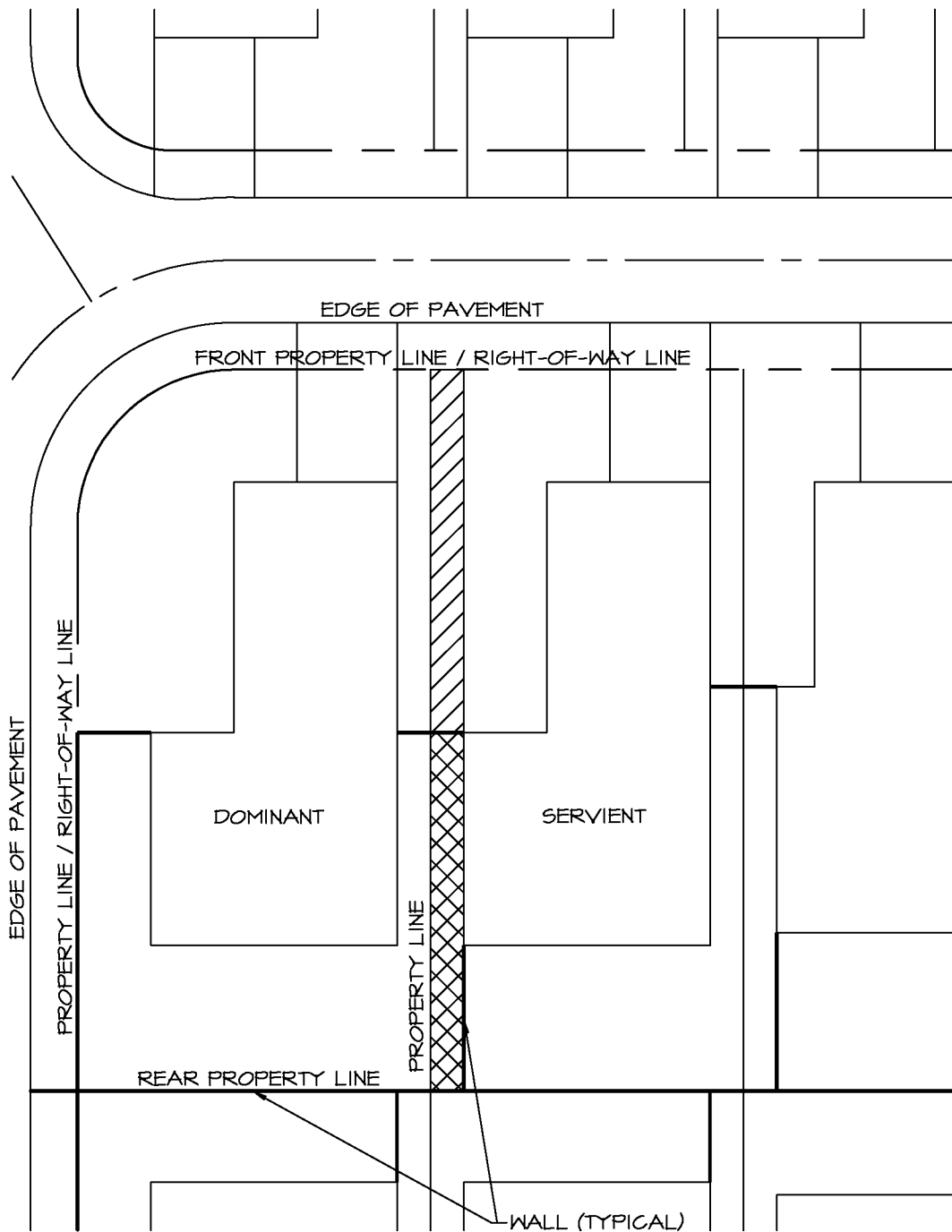
 ARCHITECTURAL REVIEW POLICY & STANDARDS	REVISIONS								
	Veranda Series Front & Rear Side Yard Easements								PAGE APPENDIX VIII



-  FRONT SIDE YARD EASEMENT
-  REAR SIDE YARD EASEMENT



**CORNER LOT "FRONT LOAD"
FRONT & REAR SIDE YARD EASEMENTS**

ISSUE DATE 5-1-22

NOT TO SCALE

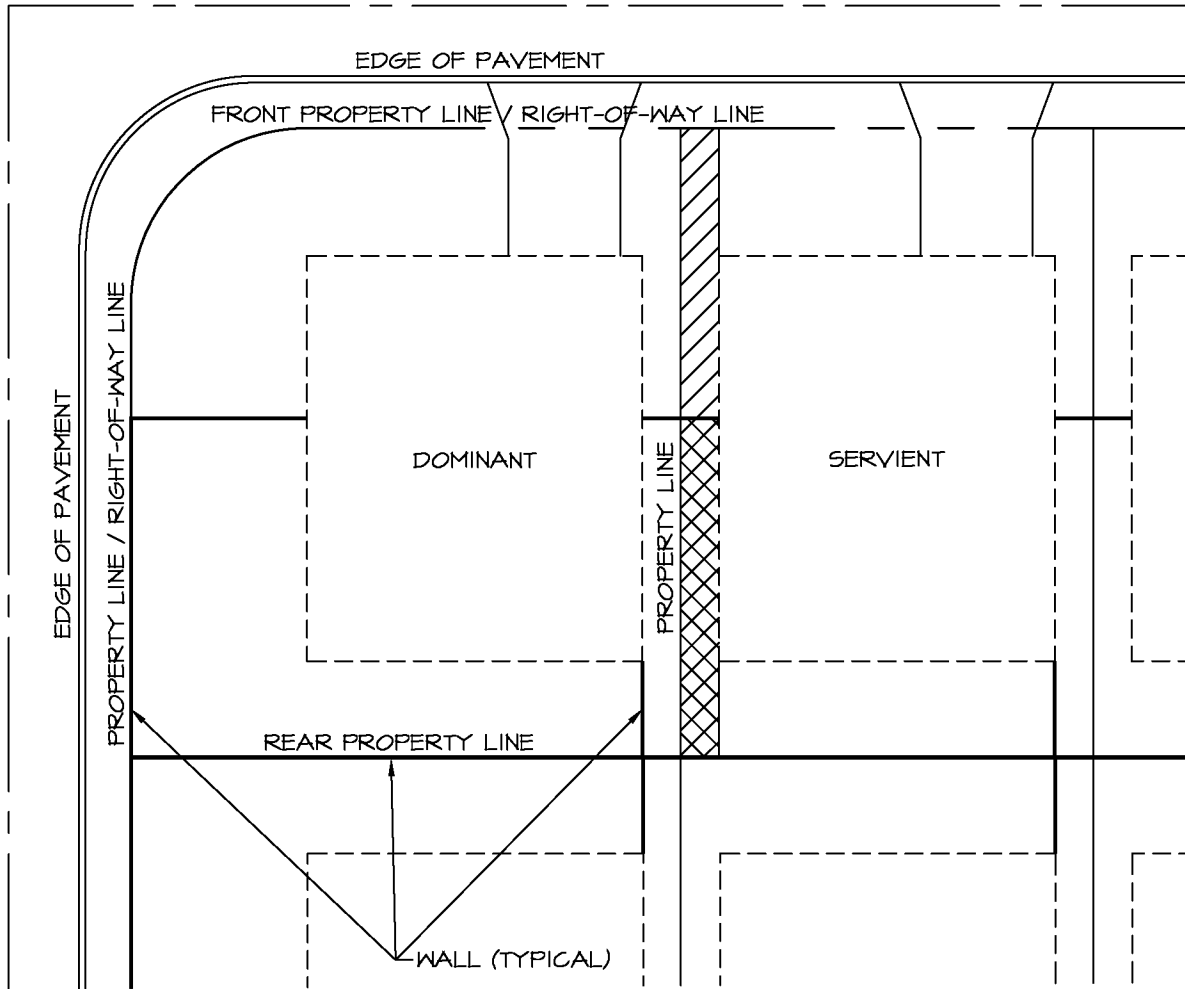
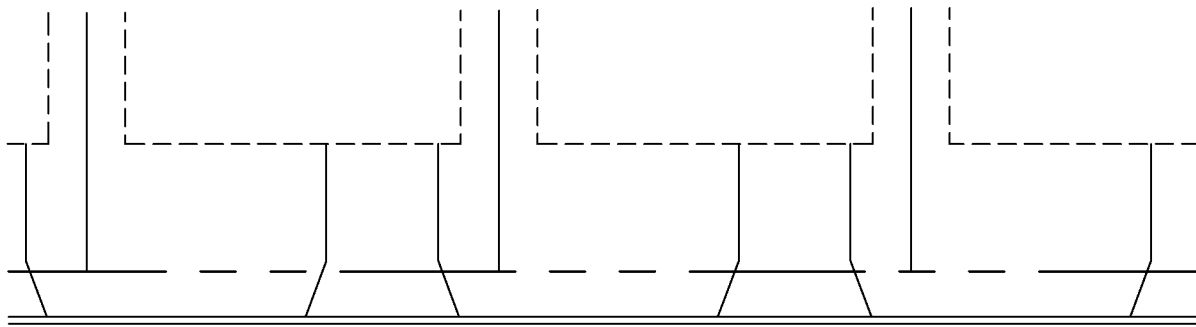
 ARCHITECTURAL REVIEW POLICY & STANDARDS	REVISIONS							
	Courtyard Villa Front & Rear Side Yard Easements							PAGE



-  FRONT SIDE YARD EASEMENT
-  REAR SIDE YARD EASEMENT



CORNER LOT
FRONT & REAR SIDE YARD EASEMENTS

ISSUE DATE 5-1-22

NOT TO SCALE

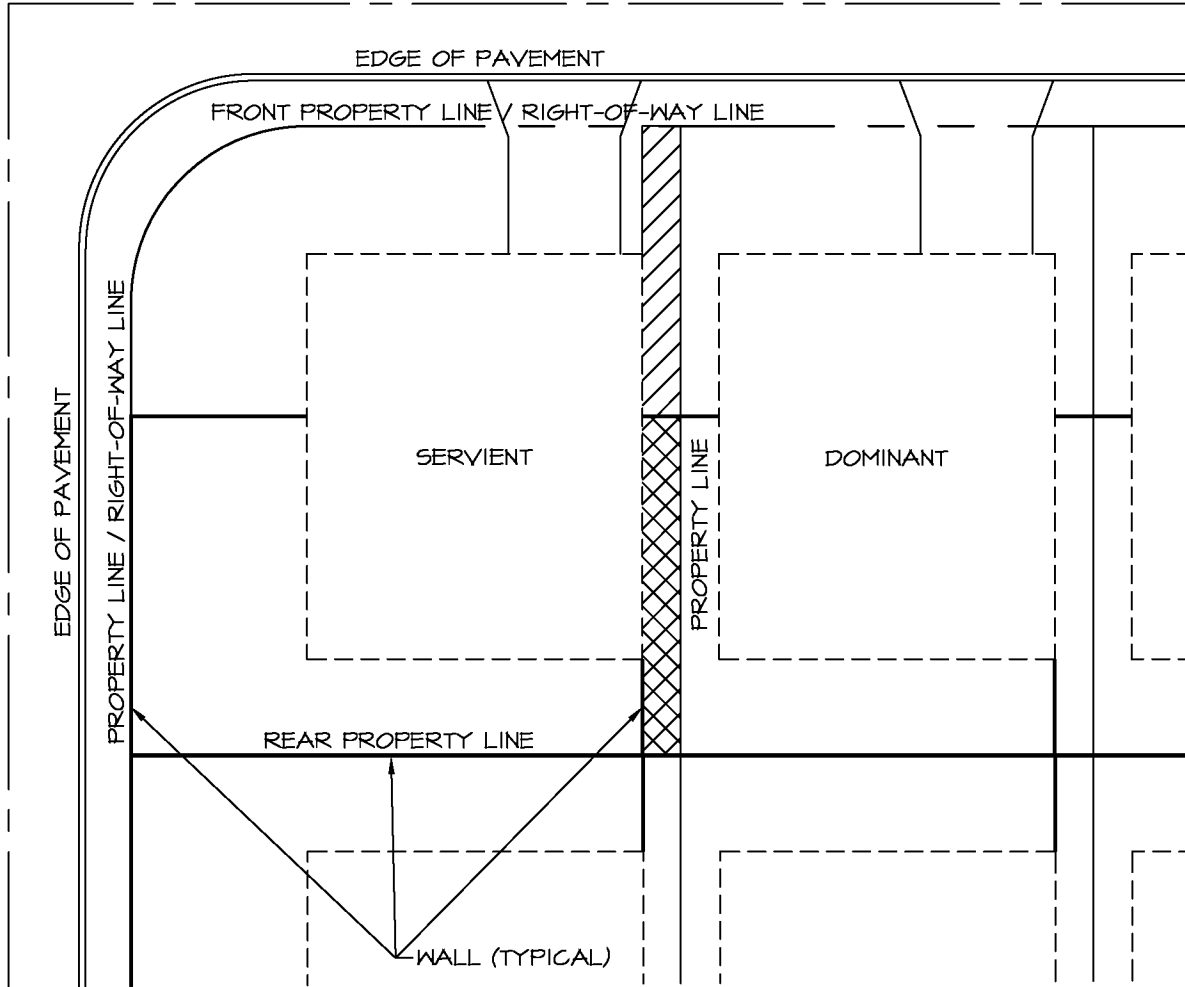
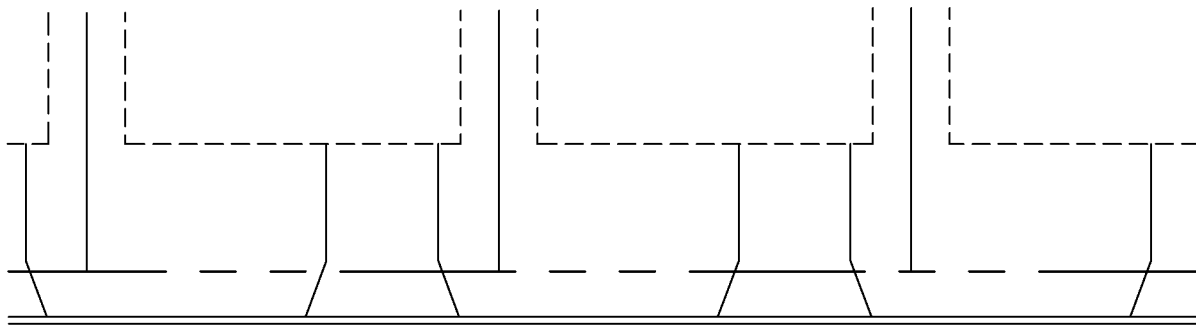
 ARCHITECTURAL REVIEW POLICY & STANDARDS	REVISIONS								
	Veranda Series Front & Rear Side Yard Easements								PAGE APPENDIX VIII



-  FRONT SIDE YARD EASEMENT
-  REAR SIDE YARD EASEMENT



**CORNER LOT
FRONT & REAR SIDE YARD EASEMENTS**

ISSUE DATE 5-1-22

NOT TO SCALE

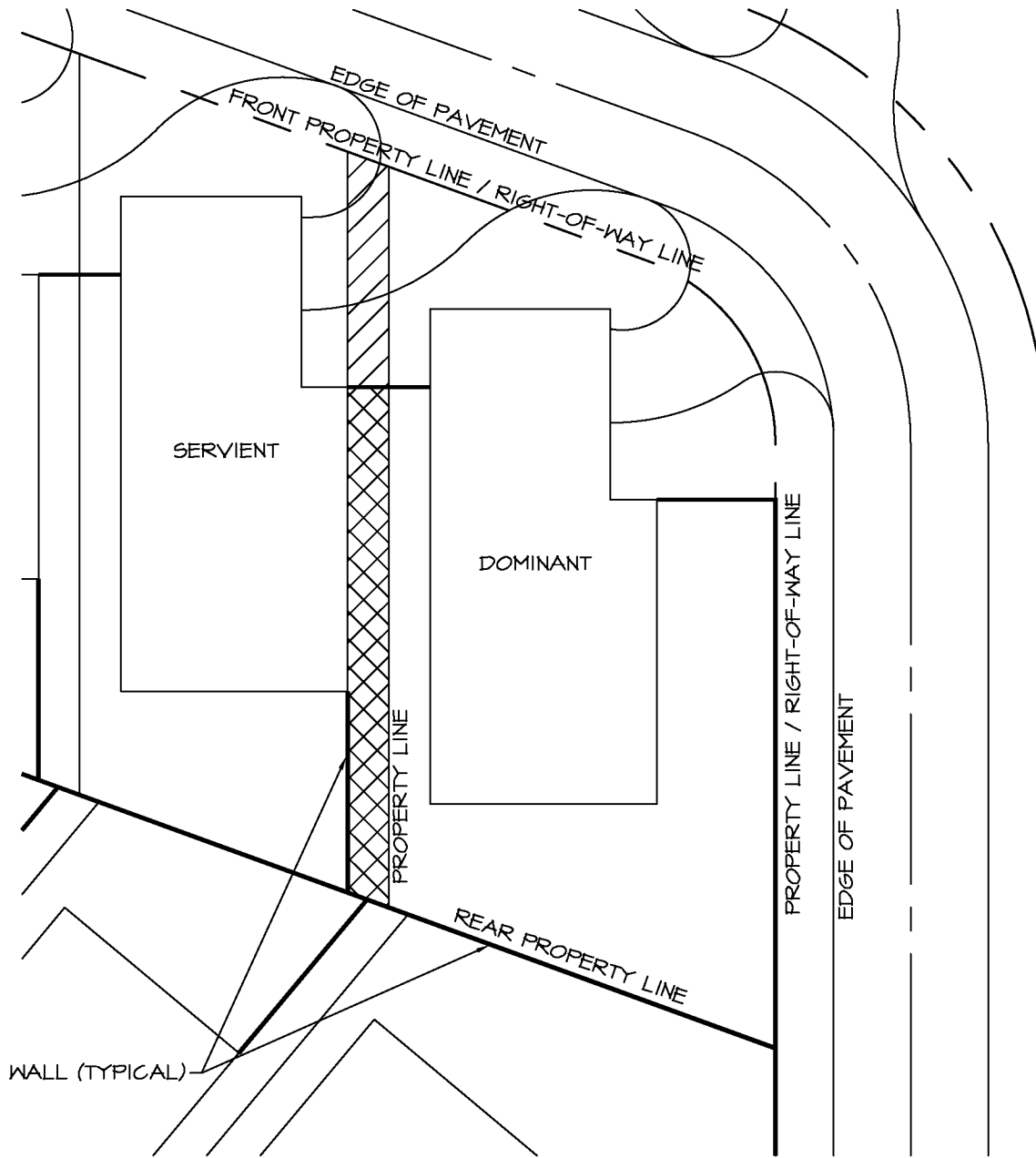
 ARCHITECTURAL REVIEW POLICY & STANDARDS	REVISIONS							
	Veranda Series Front & Rear Side Yard Easements							PAGE APPENDIX VIII



-  FRONT SIDE YARD EASEMENT
-  REAR SIDE YARD EASEMENT



**CORNER LOT "SIDE LOAD"
FRONT & REAR SIDE YARD EASEMENTS**

ISSUE DATE 5-1-22

NOT TO SCALE

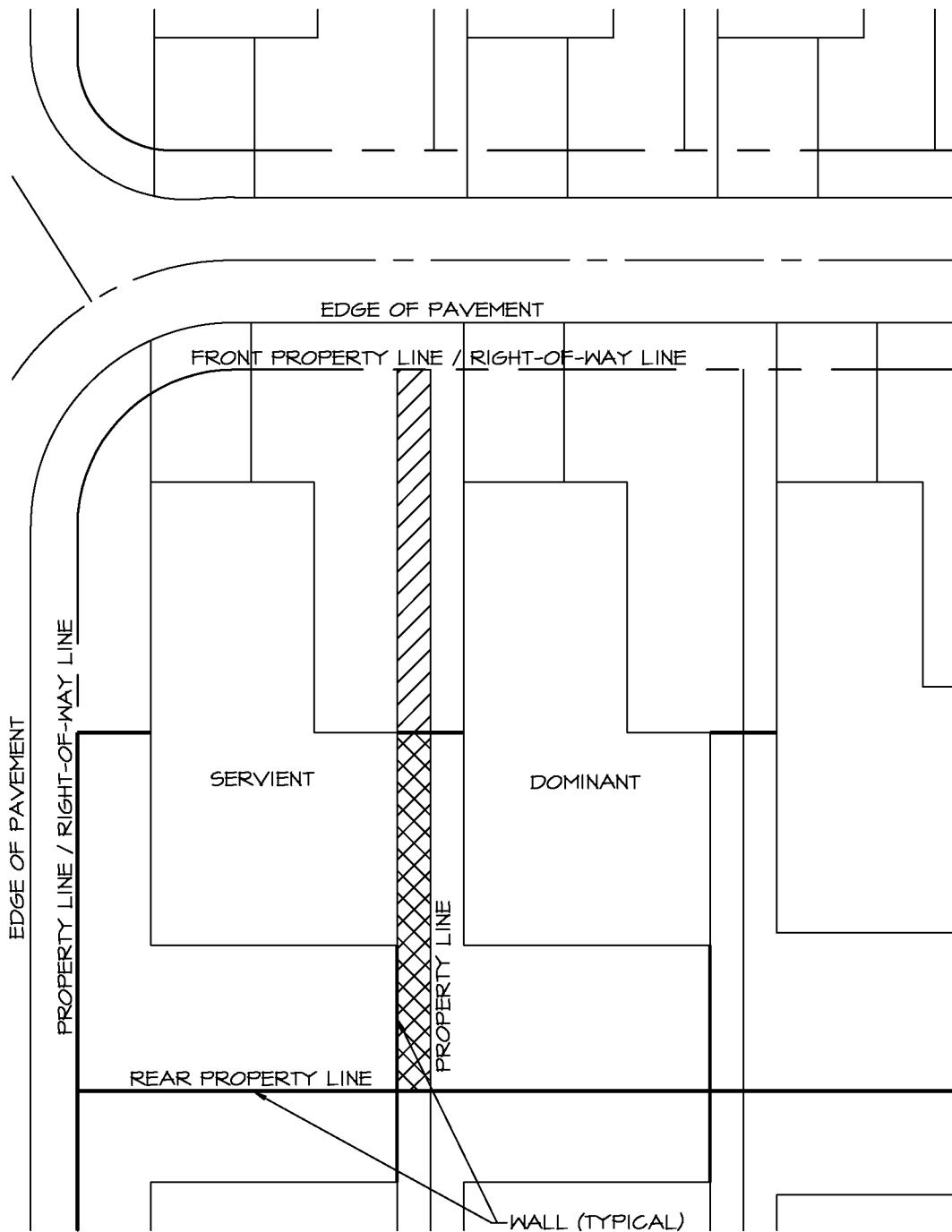
 ARCHITECTURAL REVIEW POLICY & STANDARDS	REVISIONS								
	Courtyard Villa Front & Rear Side Yard Easements								PAGE APPENDIX VIII



-  FRONT SIDE YARD EASEMENT
-  REAR SIDE YARD EASEMENT



CORNER LOT "FRONT LOAD"
FRONT & REAR SIDE YARD EASEMENTS

ISSUE DATE 5-1-22

NOT TO SCALE

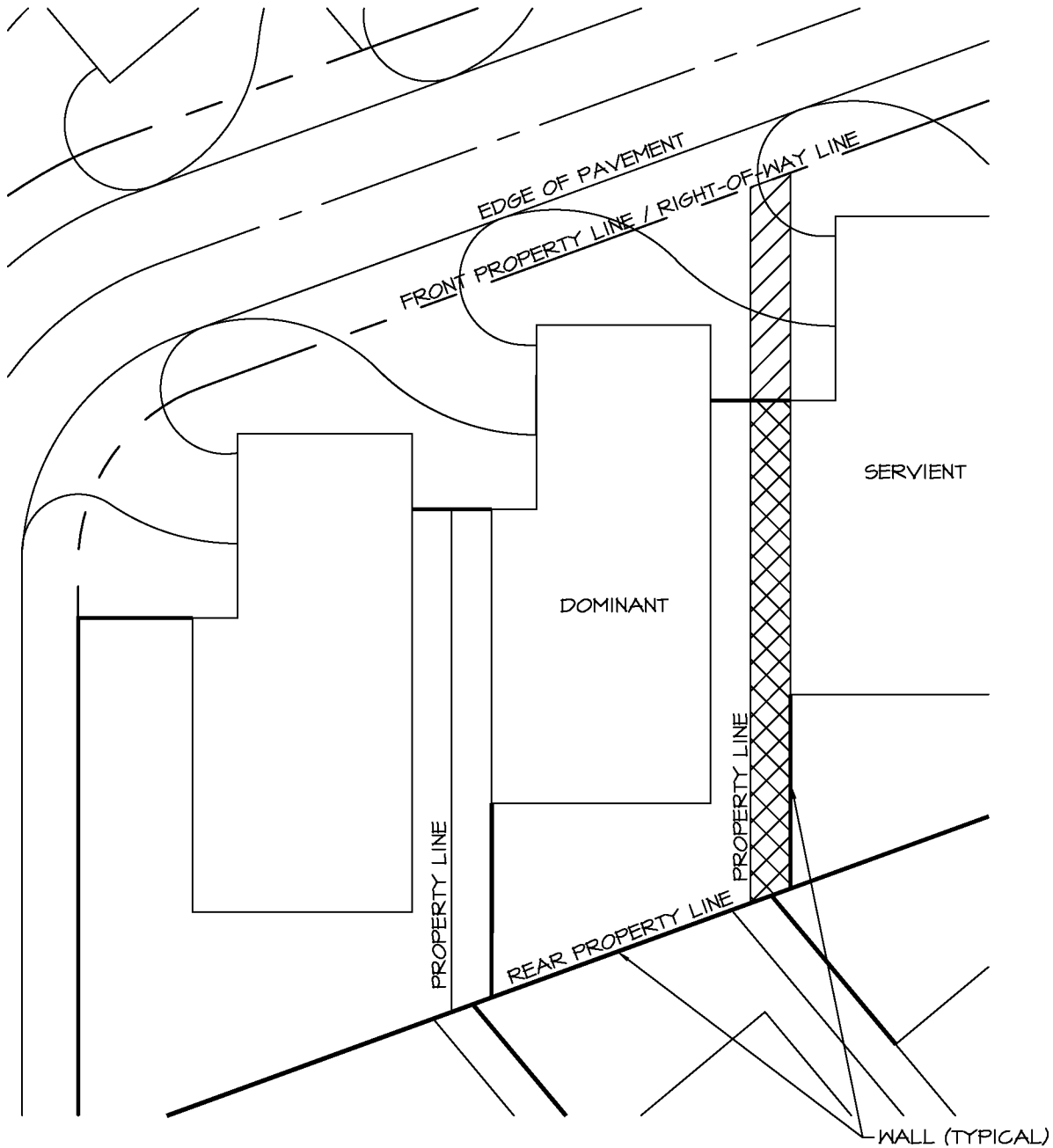
 ARCHITECTURAL REVIEW POLICY & STANDARDS	REVISIONS								
	Courtyard Villa Front & Rear Side Yard Easements								PAGE APPENDIX VIII



-  FRONT SIDE YARD EASEMENT
-  REAR SIDE YARD EASEMENT

STANDARD LOT "SIDE LOAD"
FRONT & REAR SIDE YARD EASEMENTS

ISSUE DATE 5-1-22

NOT TO SCALE

 ARCHITECTURAL REVIEW POLICY & STANDARDS	REVISIONS								
	Courtyard Villa Front & Rear Side Yard Easements								PAGE

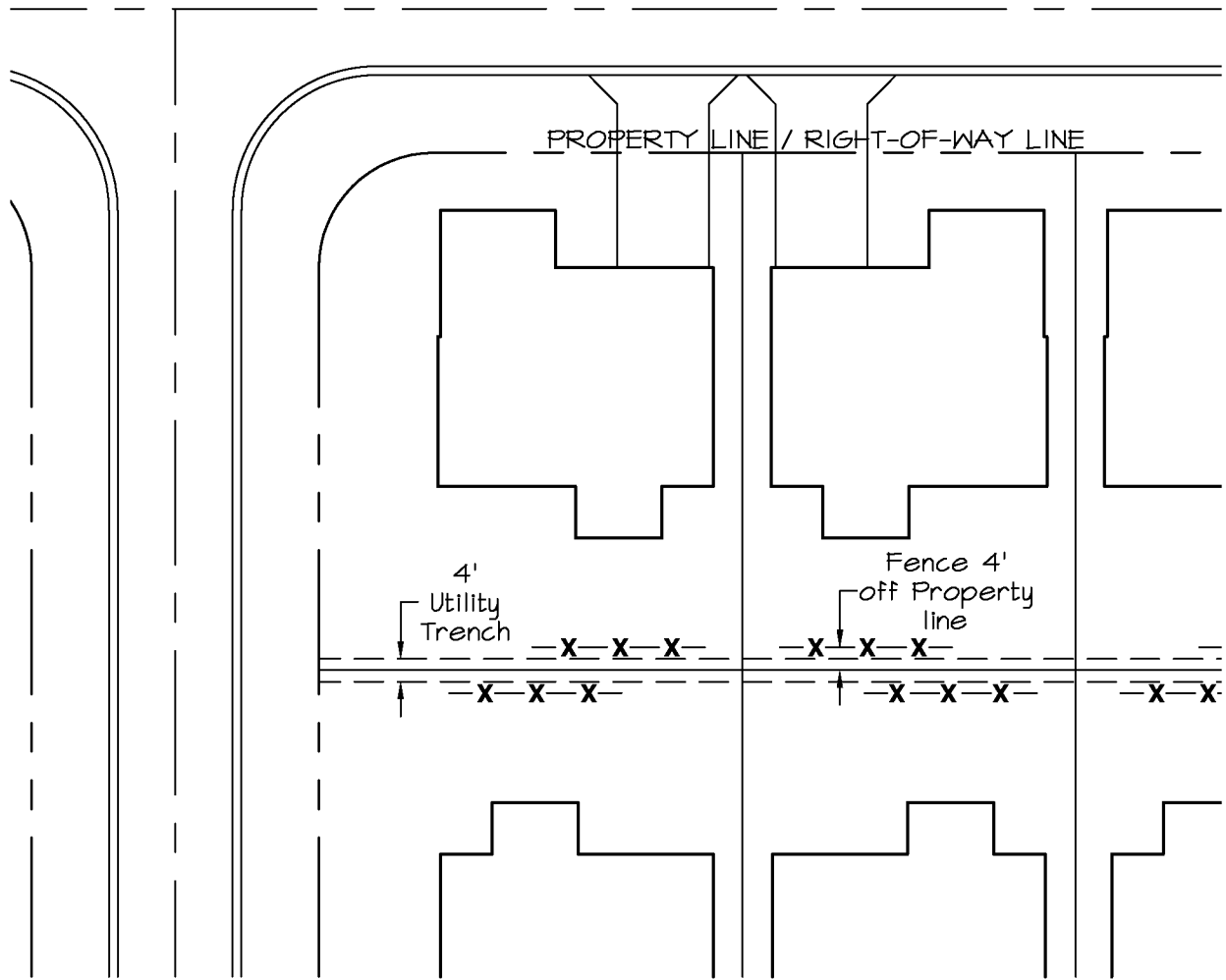
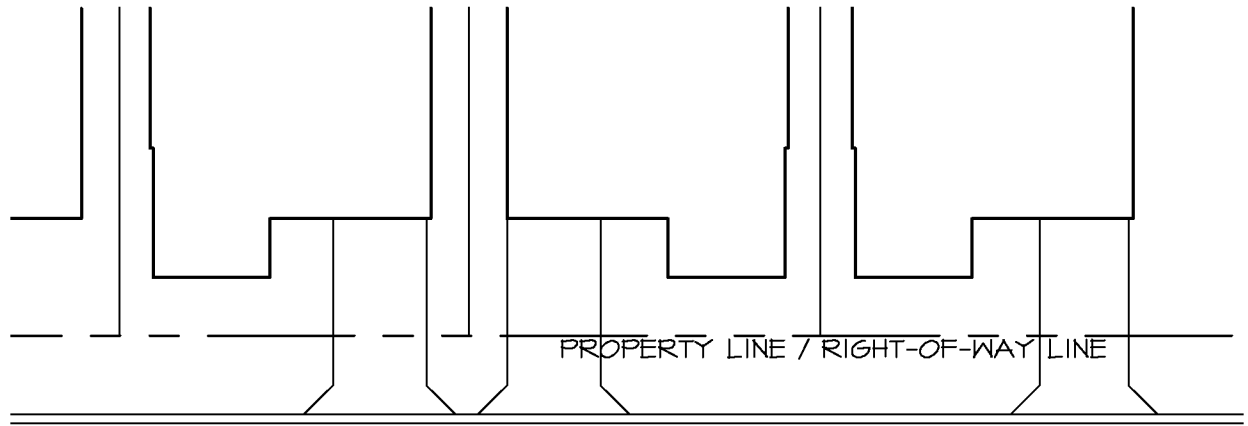

ISSUE DATE 8-21-24

NOT TO SCALE

 <p>ARCHITECTURAL REVIEW POLICY & STANDARDS</p>	<p>REVISIONS</p> <table border="1"> <tr> <td> </td> <td> </td> <td> </td> <td> </td> <td> </td> <td> </td> <td> </td> <td> </td> </tr> </table>									<p>PAGE</p> <p>APPENDIX IX</p>
<p>Premier, Designer & Cottage Home Privacy Fence</p>										

**APPENDIX IX
PREMIER, DESIGNER AND COTTAGE HOMES
PRIVACY FENCE**

Louvered Privacy Fence manufactured by Barrette Outdoor Living may be installed on Homesites In Villages of West Lake Unit No. 84 and on Premier, Designer and Cottage Home Homesites in district No. 15 with an approved Architectural Review Application.

In addition to the location, colors and size listed in this Appendices, Louvered Privacy Fences must not touch the ground in a manner that would block stormwater flow. Maximum height of the Louvered Privacy Fence is 6 feet.

Louvered Privacy Fences are only permitted on Premier, Designer and Cottage Homes that back to another home only. They are not permitted on homesites that back to a street, common area, recreation area, golf course, basin, etc.

SPECIFICATIONS

DESCRIPTION	WHITE	SAND
	MFG#	MFG#
6' x 6' Louvered Panel	73050573	73050574
5" x 5" x 102" Line Post (ZE)	73050554	73050555
5" x 5" x 102" Right End/Gate Post	73050556	73050557
5" x 5" x 102" Left End/Gate Post	73050558	73050559
5" x 5" New England Post Cap	73045003	73045004

The louvered stands at 6' tall with the posts being a little taller with the style of caps we are installing.

Louvered Privacy Fence

(Cottage, Designer and Premier PYDH Option)

30' in length

Installation:

+/- 4' from rear property line

Behind lanai

Fence cannot be located in side setbacks/easements

Color: Sand Units S222V and S229V ONLY

White all Neighborhoods (including S222V and S229V)



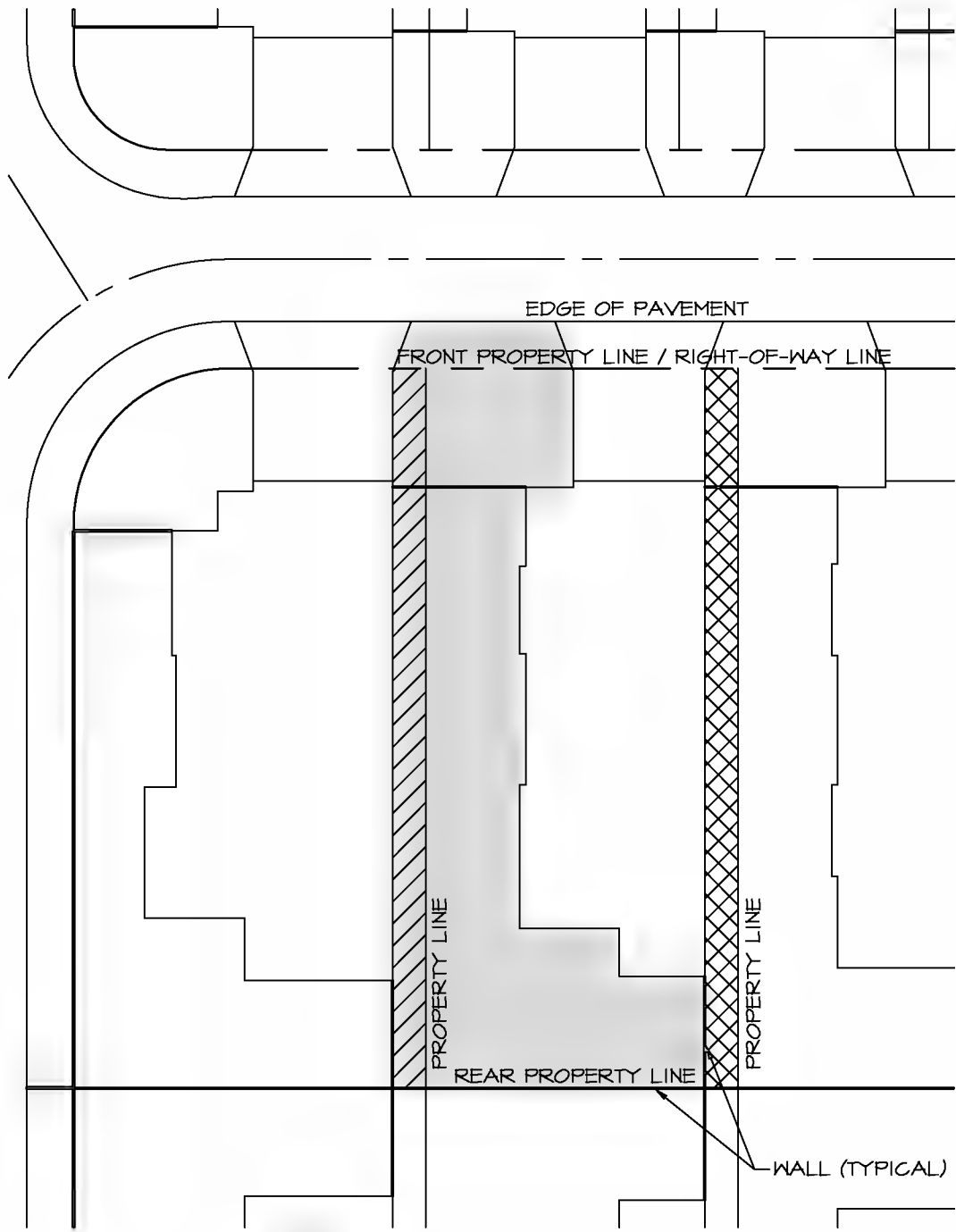

- MAINTENANCE AND USE AREA
- DOMINANT USE EASEMENT AREA
- SERVIENT USE EASEMENT AREA

STANDARD LOT MAINTENANCE AND USE EASEMENTS

ISSUE DATE 9-5-24

NOT TO SCALE

<p>ARCHITECTURAL REVIEW POLICY & STANDARDS</p>	REVISIONS							
	<p><i>Courtyard (Garden) Villa</i> Maintenance and Use Easements</p>							

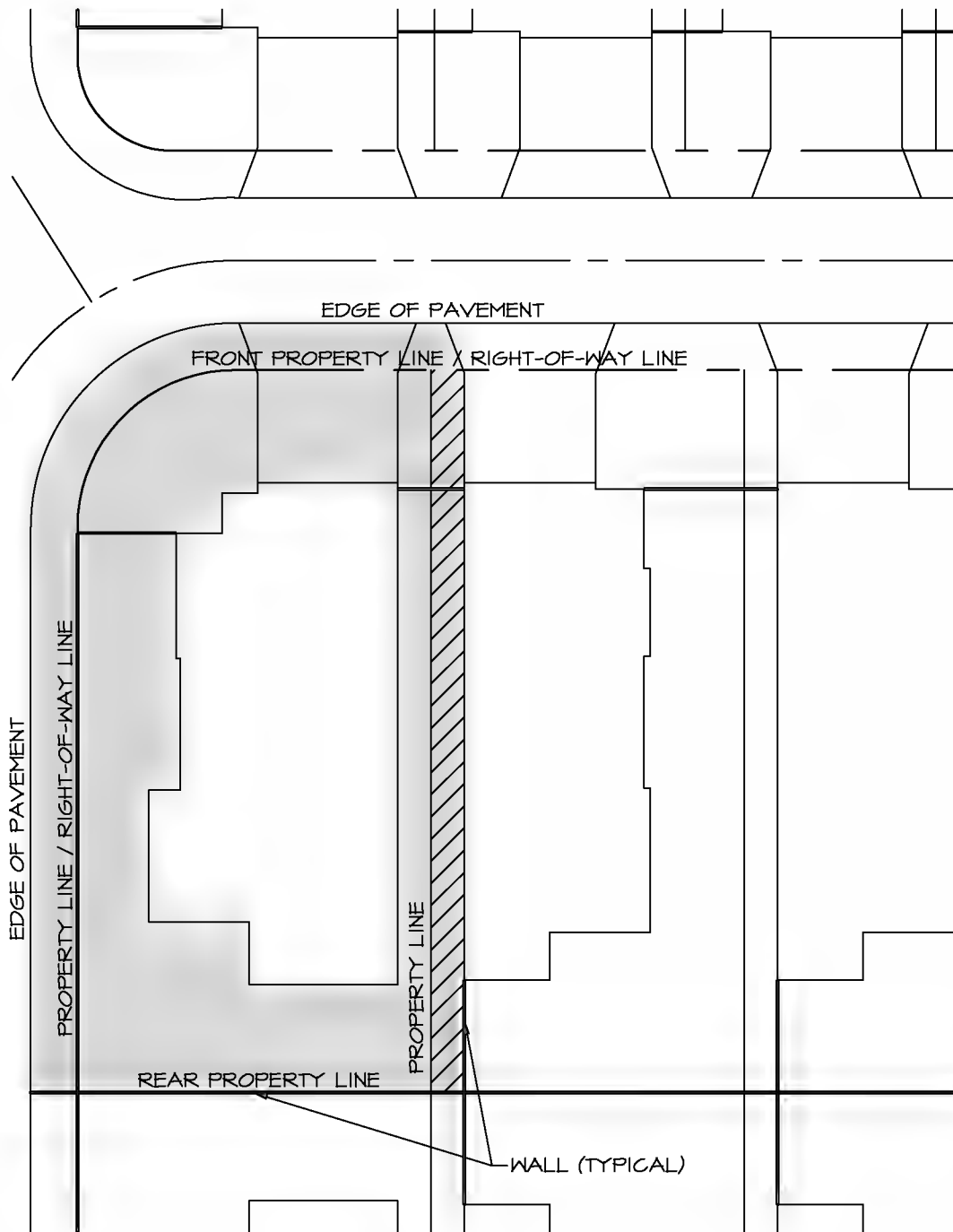

- MAINTENANCE AND USE AREA
- DOMINANT USE EASEMENT AREA

CORNER LOT MAINTENANCE AND USE EASEMENTS

ISSUE DATE 4-5-24

NOT TO SCALE

<p>ARCHITECTURAL REVIEW POLICY & STANDARDS</p>	REVISIONS							
	<p><i>Courtyard (Garden) Villa</i> Maintenance and Use Easements</p>							PAGE

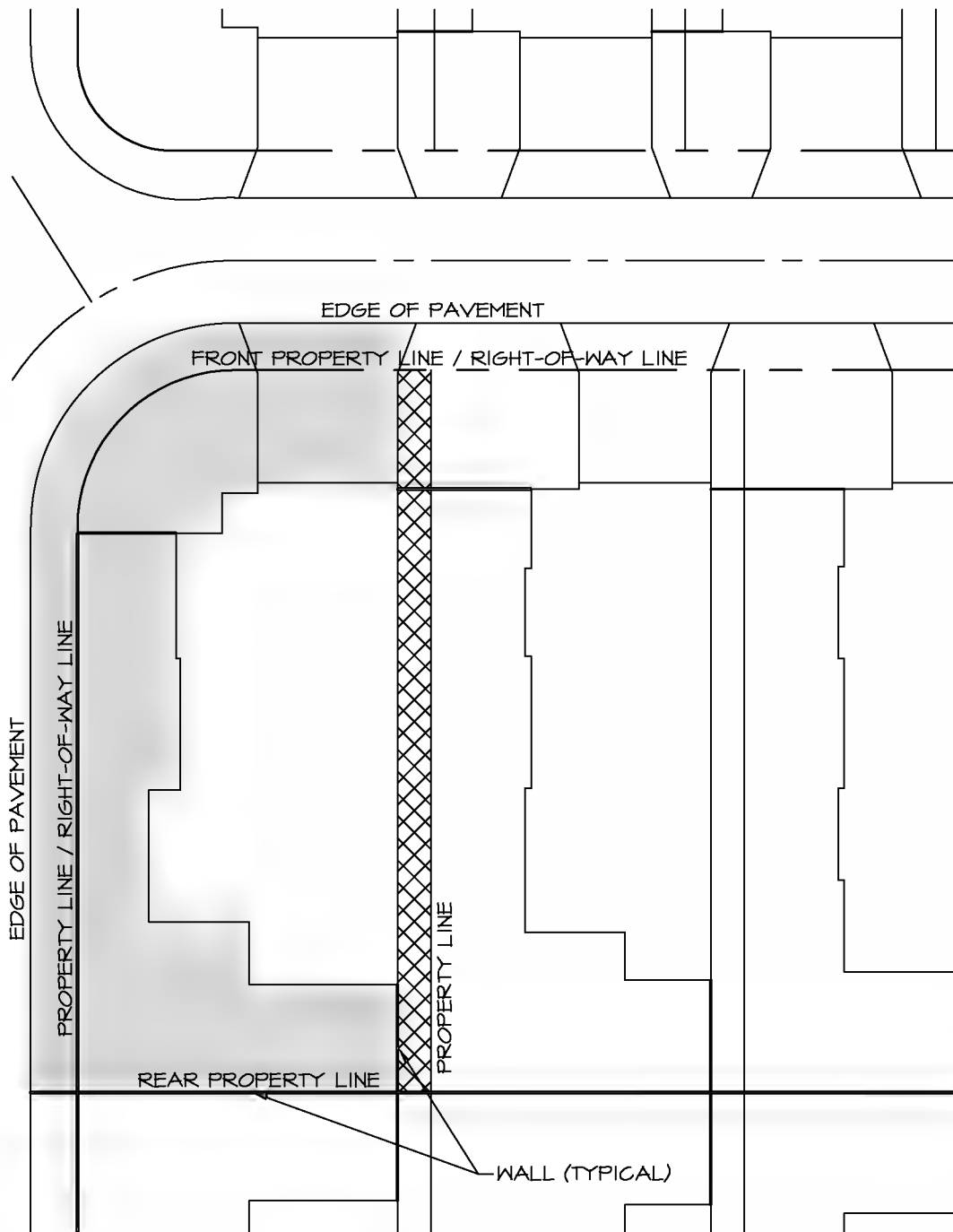

- MAINTENANCE AND USE AREA
- SERVIENT USE EASEMENT AREA

CORNER LOT MAINTENANCE AND USE EASEMENTS

ISSUE DATE 9-5-24

NOT TO SCALE

<p>ARCHITECTURAL REVIEW POLICY & STANDARDS</p>	REVISIONS							
	<p><i>Courtyard (Garden) Villa</i> Maintenance and Use Easements</p>							PAGE